

Cool C500 programme .....	02
Technical details.....	04
Cool C500 pack of legs.....	10
Tables with cable access.....	11
Operative tops.....	12
Link tops.....	12
Tops for meeting tables.....	12
Tops for contract tables .....	13
Mobile pedestals for Cool C500 .....	14
Accessories for Cool C500 .....	15
Accessories for cable management Cool C500 .....	16
Desk-mounted screen.....	17
Split Screen .....	24
Luminaria .....	25

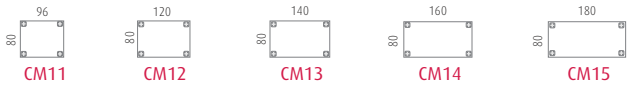

RECTANGULAR DESKS:



MEETING DESKS:

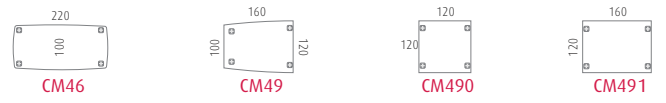

RETURNS:



CONTRACT DESKS:



EXAMPLE LAYOUTS:

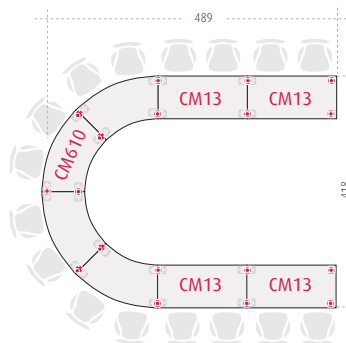
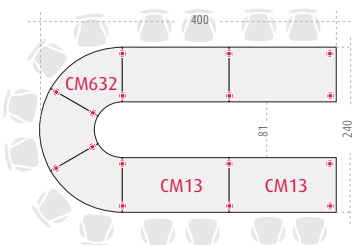
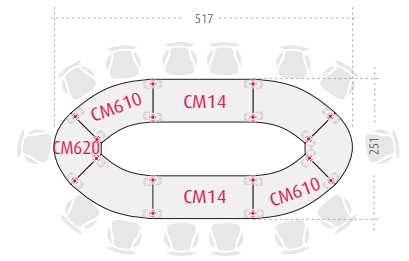
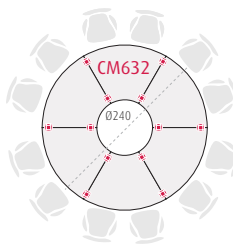
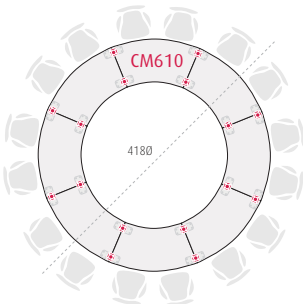
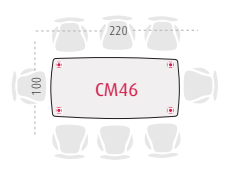
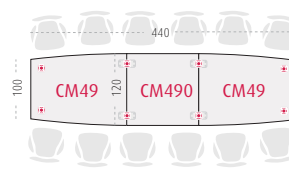
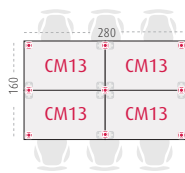
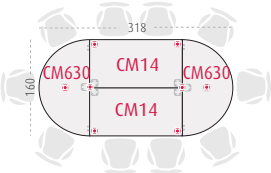

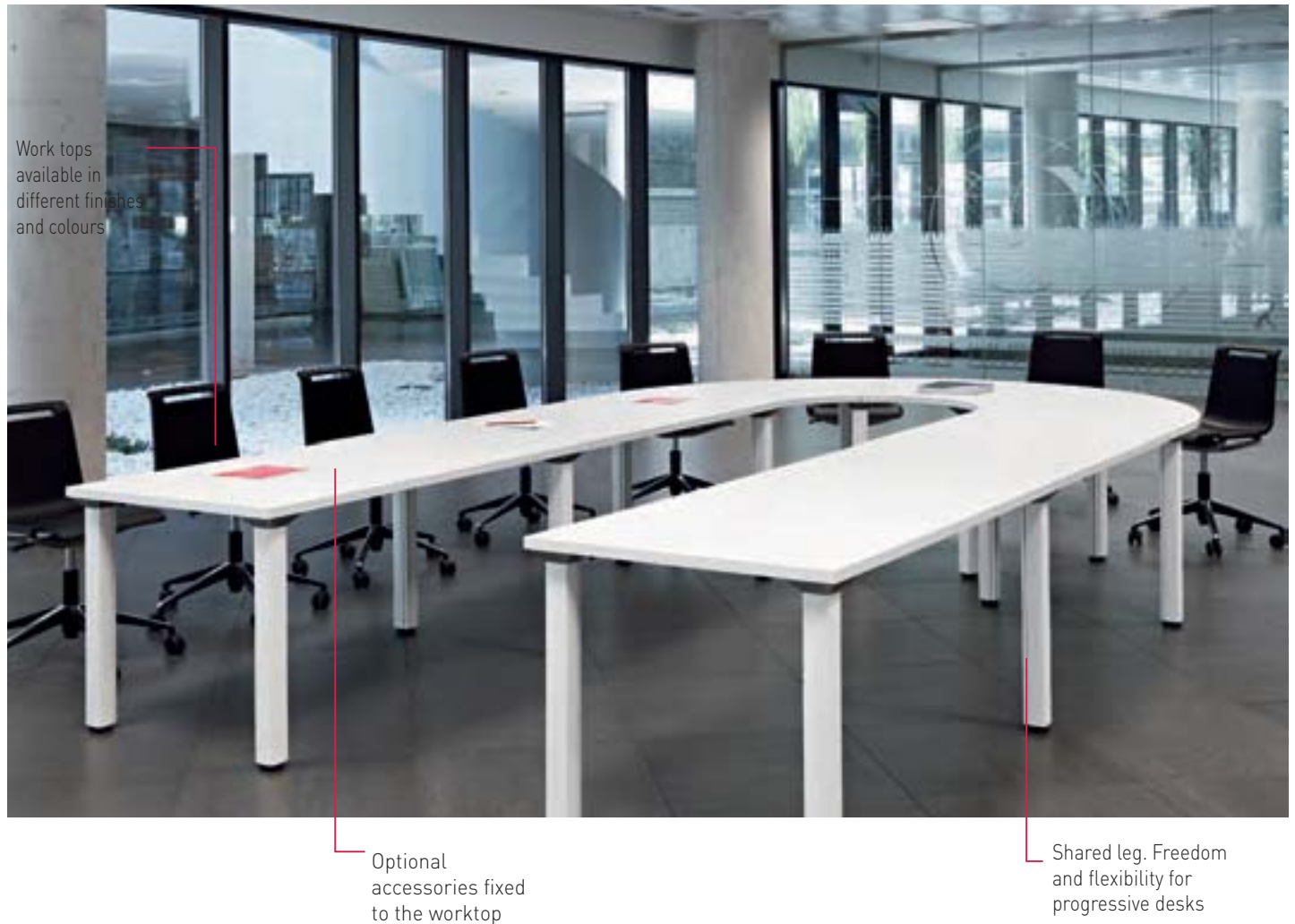

■ **FRAME AND LEG SUPPORTS**

COOL C500 has rectangular extruded aluminium legs 68x68mm, epoxy covered in silver, white or black finished. This series has an individual cable riser easy to fix at any position. Legs have anti-skid pad levellers. Top part of the leg is manufactured with moulded aluminium with epoxy finish. Assembling is quick and automatic due to the steel plate inset underneath the worktop.



■ **ELECTRIFICATION**

COOL C500 has an individual cable riser available, easily fixed to the leg to organize the cable management.

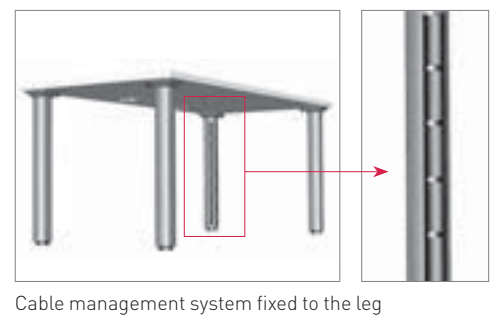

■ **FINISHES**

Melamine Plus (30mm)



(see finishes card)

High Pressure Laminate (30mm)



**■ HOW TO USE LEGS**

**COOL C500** allows the creation of multiple configurations, combining the different tops with leveler legs. Tops are sold separately to the legs which are sold in packs of two, three or four units each. It is necessary to order the number of packs according to the composition that it is going to be formed. In progressive and twin desks, legs can be shared. One click to unlocks and moves the leg.



Leg is automatically fixed to the steel plate inset underneath the top.



Individual desk use



Progressive desk use



Twin desk use



OPEN-UNLOCKED



CLOSED-LOCKED

Quick assembling system without screws. Just one movement to lock and close

**INTUITIVE-EASY**

30mm tops can receive legs at any position, and also receive different accessories such as modesty panels, electrification channels, returns and so on...

**SHARED LEG. FREEDOM AND FLEXIBILITY FOR PROGRESSIVE DESKS**

COOL offers flexibility for the different layouts used in Universities, business schools or meetings. Legs can be shared by two or four desks and allow logistic and economic savings.

**ORGANIC AND PERSONAL SHAPES**

Organic shapes that adapt perfectly to any environment. Interior designers and architects will be able to create different layouts in their different projects.

**RE-USE THEM AT ANY TIME. ECONOMIC AND SPACE SAVING.**

Making different layouts with the same components is very simple and cheap.

**DIFFERENT ELEMENTS. TOPS AND LEGS**

Top and legs are sold separately; you can order the legs as per your needs. Keeping different top finishes and sizes as well as legs with levelers, castors or height adjustable systems, in your warehouse will allow you to create any configuration at any time.



Rectangular desks

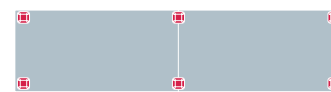

Progressive desks

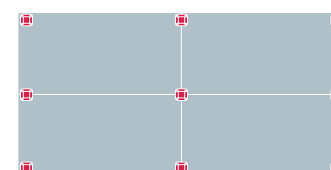

Twin desks

■ DESKMOUNTED SCREENS INSTALLATION AND CONFIGURATION

All the 80cm rectangular desks from COOL C500 can be fitted on a back to back layout in two different ways, so they leave a central gap for screens to be used as a bench or without a gap for meeting table purposes. To do that the desk will be handled so the legs from one of the sides will be recessed by 5mm.

Please consider the leg position when assembling because you always need to link same top sides so the legs match.

**NOTE:** The double desks with electrification cable outlets 'Y' have a **UNIQUE** assembling position. The outlets 'Y' will **ALWAYS** be machined on the sides of the board A and A, so that they are closer to the side fixed by the dividers.

Models:

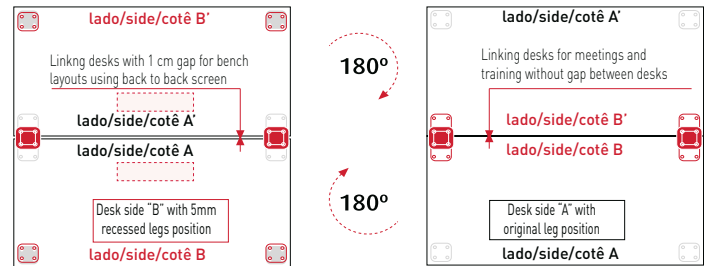
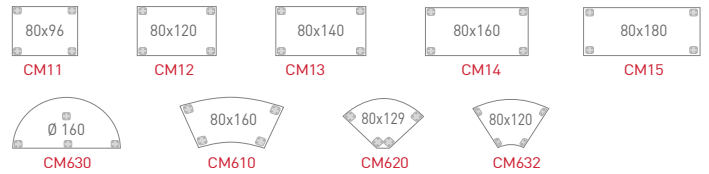

The D-end tops ref CR630 only can be used when there is no gap between desks back to back (on meeting layouts), not in bench layout with the gap in the middle for the screens.

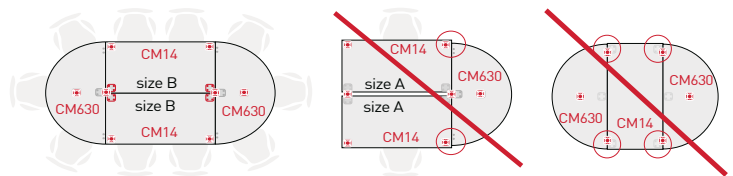

■ NON RECESSED LEG

When there is no gap in between the legs, recessed legs are not available

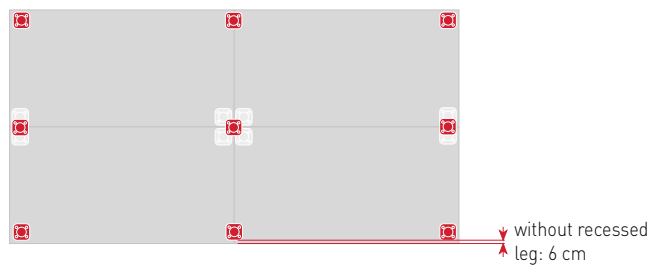

■ RECESSED LEG

COOL C500 is not available with recessed legs. The metal inserts in the tops have only one position for individual use and one for the progressive.

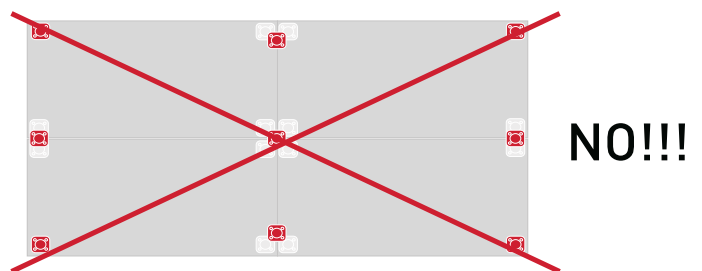



**MATERIALS**

**COOL C500** has been designed to be manufactured with recycled materials, danger substances such as chrome, mercury or cadmium are not used in big quantities. Aluminium, steel and woods are 100% recyclable. Organic volatile Components. Packages manufactured with recycled carton. Ink thinner free.

Legs: **92,47%**  
Tops: **79,59%**  
recycled materials



**100%** recyclable Aluminium  
**100%** recyclable Steel  
**100%** recyclable Woods



**PRODUCTION**

Energy use is optimized during the production process. Minimal environmental impact. Last generation technological system used in paint production and coating processes, with excess paint recovered for re-use. Zero COVs emissions and other contaminant gases. Closed water circuit to clean the metals. Heat recovery. Automatic manufacture systems. Cut process is planned.



Legs: **93,55%**  
Tops: **98,06%**  
recyclable materials



Recycled package and thinner free **100%** recyclable carton



**TRANSPORT**

Optimum packaging to reduce space in transport and save energy.



Easy to clean and maintain



**USE**

Long lasting use. Spare parts and replacements available. Easy to clean and maintain.



**DISPOSAL**

Recyclable. Easy and quick to split **COOL C500** components. Packages are reused by our supplier to avoid waste generation. Carton used in packages is recyclable.

**CERTIFICATES AND REFERENCES**

The different programmes get points in different environmental categories to get the LEED certificate (sustainability, material and resources, water, energy and atmosphere, inner environment quality, innovation and design).



The mark of responsible forestry



PEFC Certificate



EN ISO 14006:2011  
ECODESIGN Certificate



UNE-EN ISO 9001:2008  
ISO 9001 Certificate



UNE-EN ISO 14001:2004  
ISO 14001 Certificate



E1 by EN 13986  
Certificate



ACTIU TECHNOLOGICAL PARK  
project certified as LEED® GOLD  
by U.S. Green Building Council 2011  
Leadership in Energy & Environmental Design

## ■ ERGONOMICS

**COOL C500** available for all type of users. Perfect for any need and keeps user's posture in a natural way without any manual adjustment.

## ■ STANDARDS

**COOL C500** has passed tests done in our technical department as well as the tests done in **AIDIMA** the Technological Institute for furniture.

The tests correspond to **UNE** standards and office desks:

- **UNE: EN 527-1:2011.** Office Furniture. Desks. **Part 1:** Dimensions.
- **UNE: EN 527-2:2003.** Office Furniture. Desks. **Part 2:** Mechanical security requirements.
- **UNE: EN 527-3:2003.** Office Furniture. Desks. **Part 3:** Test to determine stability and structure resistance.

## ■ ECOLOGY

### ENERGY SAVING

The new technological production system included, reduces the energy resources used to manufacture each component. Materials are very well used to avoid wastes.

### RECYCLED AND RECYCABLE MATERIALS

ACTIU's environmental policy opts to use recycled materials in those components that do not constrain the operation and durability of our products. Materials used in **COOL C500** such as Aluminium, Steel or Wood are totally recyclable.

### SUSTAINABLE CERTIFICATE

ACTIU has **PEFC and FSC** certificate to prove that the wood used in our products comes from sustainable exploitations and **ECODESIGN ISO 14006** certificate.

**■ REMARKABLE VALUES**

**1** – Electrostatic coat, epoxy bonding 2nd generation. Polymerized 200°C with nano-ceramic and non-grease treatments to improve covering and provide better resistance and durability.

**2** – Coating 80-90 microns thick (it could be different as per the project requirements).

This covering guarantees the finish and maintenance of metal structures.

**3** – Painting process:

Actiu painting plant has minimal environmental impact against the traditional industry processes.

Treatment is done by polarized coating and compacted with temperature. We get homogeneous and regular application with 98% use, while the remaining 2% is used to produce other paints. Paints used are COVs free (Volatile Organic Components) which are very dangerous for the environment. All water used in the process is re-used, so we get zero dump. The process is free in heavy metal, phosphate, organic components and DQD (Biochemical demand of Oxygen). This system allows an exact control of thickness, providing a standard thickness of 90 microns onwards.

Antibacterial finish

**4** – ACTIU has **PEFC and FSC** certificate to prove that the wood used in our products comes from sustainable exploitations and **ECODESIGN ISO 14006** certificate.



HOW TO USE LEGS

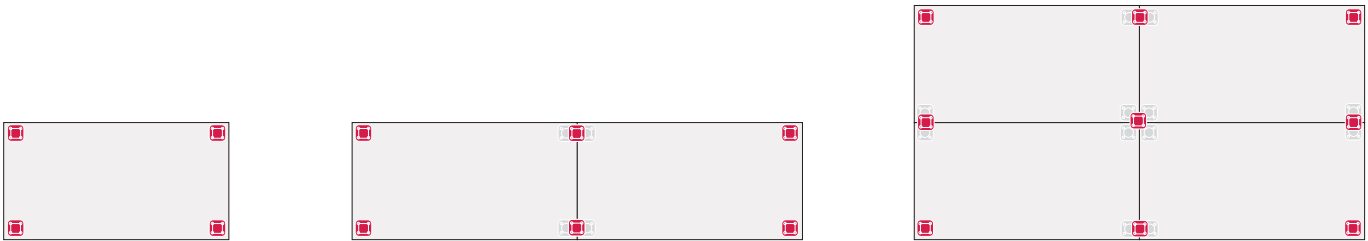

COOL C500 program allows to create multiple configurations combining tops and legs with levelers, castors or height adjustable. Tops are sold separately to the legs. Legs are sold in packs of 2,3 and 4 units. You will have to order number of packs according to the compositions you want to create. You must remember that in progressive or double desks two tops can share one leg. Please find below some examples:

EXAMPLE:

INDIVIDUAL DESK

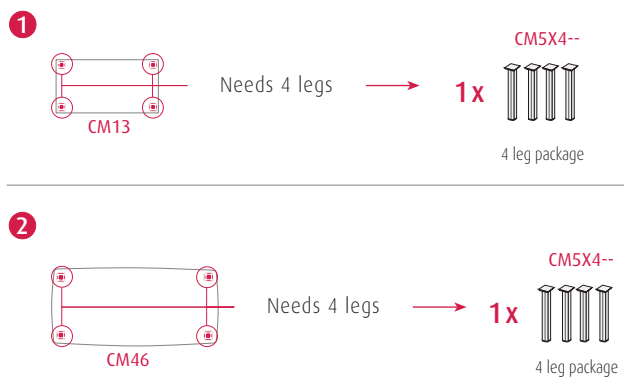

PROGRESSIVE DESK:

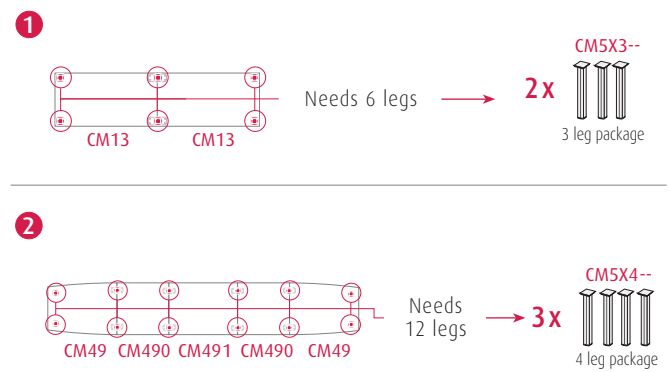

TWIN DESKS:

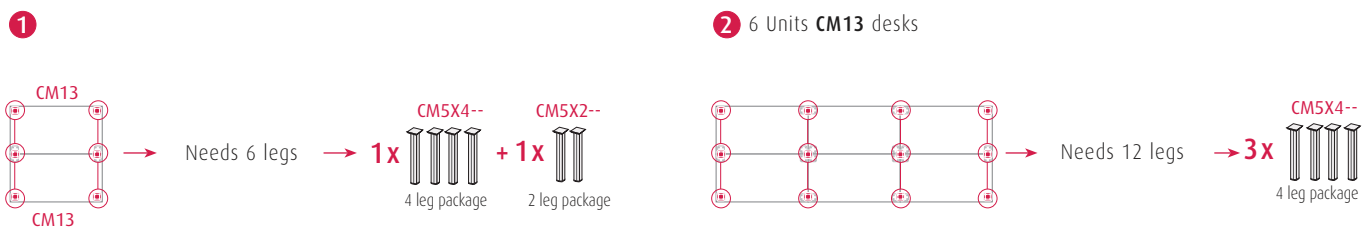

CONTRACT TABLES:

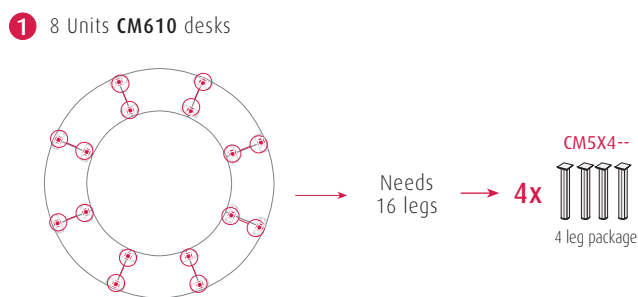

**FINISH CODE**

To order a product, you will have to complete the reference with the **finish code** replacing the two hyphens by the finish you need. Finishes available will be shown in the column price.  
 Sample: CM5X21-- in white aluminium --> CM5X2100

	WHITE	SILVER	BLACK
ALUMINIUM	00	02	08

**TECHNICAL FEATURES OF THE FRAME**

**Legs:**



1,5 mm thick extruded aluminum, special shape 68 x 68 mm epoxy finish. Available in white, silver and black.

**Leg Options:**





With Levelers  
 Total Height:  
 74 cm.

Moulded ABS silver coating, white or chromed depending of the option. Leveler always silver or dhchromed.

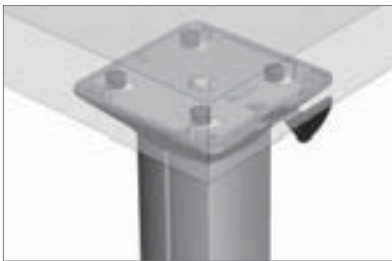
**QUICK ASSEMBLY SYSTEM:**

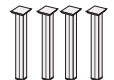

The quick assembly system in **COOL C500** allows to fix the legs to the top by a steel plate inset underneath of the top. After inserting the leg into the plate then it is locked by a lever.

MODEL AND SIZES	LEG OPTIONS	REFERENCES	WHITE	R.R.P. PACK SILVER	BLACK	PACKAGING (packs · vol. · weight)
<b>CM5X2</b> 2 leg package 	Levelers	<b>CM5X21--</b>	117,60	117,60	117,60	N° Packs: 1 Vol.: 0,018 m3 Weight: 4 kg
<b>CM5X3</b> 3 leg package 	Levelers	<b>CM5X31--</b>	179,20	179,20	179,20	N° Packs: 1 Vol.: 0,030 m3 Weight: 5,5 kg
<b>CM5X4</b> 4 leg package 	Levelers	<b>CM5X41--</b>	236,60	236,60	236,60	N° Packs: 1 Vol.: 0,030 m3 Weight: 6,5 kg

CABLE ACCESS DESKS

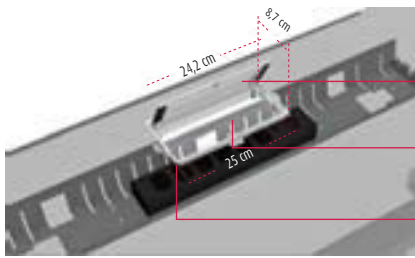

- Flip-up polyamide door with "Push-Latch" system
- Cable access
- Polyamide frame adjustable from 13 mm to 30 mm high

- To order desks with cable access, please add "T" at the end of the reference (central), "TL"(left hand side),"TR"(right hand side).
- Models with this standard cable access has the icon next to the code
- desk price with the cable access is as per the attached table.
- To order different desks which the electrification access is not standard, **please check sales team.**

**CABLE ACCESS**

	MFC	HPL
RRP UNIT	26,60	27,30

INDIVIDUAL SAMPLES

CM13 T

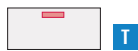
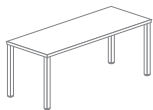

REFERENCE	RRP DESK	RRP LEGS	RRP CABLE ACCES	RRP TOTAL
CM1300T	127,40 (x1)	236,60 (x1)	26,60 (x1)	390,60

Cool C500 desk **CM13** in white mfc, silver frame, levelers, central cable access

PROGRESSIVE SAMPLE

CM14 T

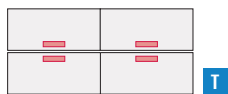
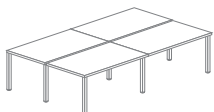

REFERENCE	RRP DESK	RRP LEGS	RRP CABLE ACCES	RRP TOTAL
CM1400T (X4)	135,80 (x4)	179,20 (x3)	26,60 (x4)	848

Bench desk Cool with 4 desks **CM14** white MFC top finish, silver frame with levelers and top access for the 4 tops.

"Y" WIRING ACCES

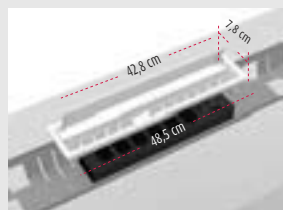

"W" WIRING ACCES

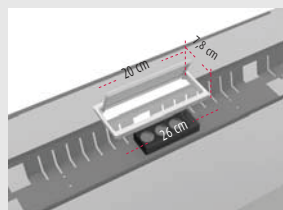

**ALUMINIUM WIRING ACCESS (Y / W) - FOR PROJECTS**

- Trama offers the possibility of including aluminium access to wiring in different position if required. (Y / W)
- For requesting this option, please contact our **head office's commercial team.**





**FINISH CODE**

To order a product, you will have to complete the reference with the **top finish**, replacing the two hyphens by the finish you need.  
 Finishes available will be showed in the column price.  
 Sample: CM11-- WHITE MFC will be --> CM1100

	WHITE	MAPLE	LIGHT OAK	ELM	WALNUT-N
MFC	00	18	16	12	13
HPL	20	28			

**TOPS DO NOT INCLUDE LEGS. YOU MUST ORDER THEM SEPARATELY**

**TOPS FOR OPERATIVE DESKS**

MODEL AND SIZES	REFERENCES	MFC	HIGH PRESSURE LAMINATED (HPL)	PACKAGING (packs · vol. · weight)
<b>CM11</b> 	<b>CM11--</b>	103,60	145,60	Nº Packs: 1 Vol.: 0,023 m3 Weight: 14 kg
<b>CM12</b> 	<b>CM12--</b>	117,60	127,40	Nº Packs: 1 Vol.: 0,027 m3 Weight: 17 kg
<b>CM13</b> <b>T</b> 	<b>CM13--</b>	127,40	183,40	Nº Packs: 1 Vol.: 0,04889 m3 Weight: 19 kg
<b>CM14</b> <b>T</b> 	<b>CM14--</b>	135,80	204,40	Nº Packs: 1 Vol.: 0,015 m3 Weight: 22,5 kg
<b>CM15</b> <b>T</b> 	<b>CM15--</b>	151,20	225,40	Nº Packs: 1 Vol.: 0,084 m3 Weight: 30 kg

Individual cable management in COOL C400 is only available in the references in this page. For other sizes and models, please check page 13.

**CABLE ACCESS**







	MFC	HPL
RRP UNIT	26,60	27,30

**TOP FOR RETURN**

MODEL AND SIZES	REFERENCES	MFC	HIGH PRESSURE LAMINATED (HPL)	PACKAGING (packs · vol. · weight)
<b>CM630</b> 	<b>CM630--</b>	145,60	214,20	Nº Packs: 1 Vol.: 0,0753 m3 Weight: 21 kg

**TOPS FOR MEETING TABLES**



MODEL AND SIZES	REFERENCES	MFC	HIGH PRESSURE LAMINATED (HPL)	PACKAGING (packs · vol. · weight)
<b>CM46</b> 	<b>CM46--</b>	232,40	380,80	Nº Packs: 1 Vol.: 0,116 m3 Weight: 45 kg
<b>CM49</b> 	<b>CM49--</b>	198,80	329,00	Nº Packs: 1 Vol.: 0,1330 m3 Weight: 37 kg
<b>CM490</b> 	<b>CM490--</b>	161,00	257,60	Nº Packs: 1 Vol.: 0,0998 m3 Weight: 30 kg
<b>CM491</b> 	<b>CM491--</b>	193,20	322,00	Nº Packs: 1 Vol.: 0,1330 m3 Weight: 40 kg

**FINISH CODE**

To order a product, you will have to complete the reference with the **top finish**, replacing the two hyphens by the finish you need. Finishes available will be showed in the column price.  
 Sample: CM610-- WHITE MFC will be --> CM61000

	WHITE	MAPLE	LIGHT OAK	ELM	WALNUT-N
MFC	00	18	16	12	13

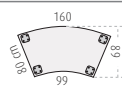
**TOPS FOR CONTRACT TABLES**

MODEL AND SIZES	REFERENCES	MFC	HIGH PRESSURE LAMINATED (HPL)	PACKAGING (packs · vol. · weight)
<b>CM610</b> 	<b>CM610--</b>	175,00	282,80	Nº Packs: 1 Vol.: 0,082 m3 Weight: 24 kg
<b>CM620</b> 	<b>CM620--</b>	147,00	226,80	Nº Packs: 1 Vol.: 0,070 m3 Weight: 14,5 kg
<b>CM632</b> 	<b>CM632--</b>	145,60	221,20	Nº Packs: 1 Vol.: 0,057 m3 Weight: 14,5 kg

Sample layouts

**DESK-MOUNTED SCREENS INSTALLATION AND CONFIGURATION**

All the 800 mm rectangular desks from COOL C500 can be fitted on a back to back layout in 2 different ways, so they leave a central gap for screens to be used as a bench or without a gap for meeting table purposes. To do that the desk will be handed so the legs from one of the sides will be recessed by 5 mm.

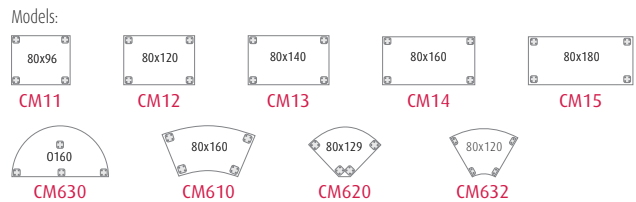

Please consider the leg position when assembling because you always need to link same top sides so the legs match.

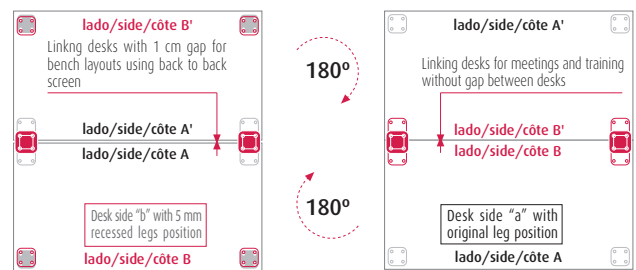

The D-end tops ref CM630 only can be used when there is no gap between desks back to back (on meeting layouts), not in bench layout with the gap in the middle for the screens.

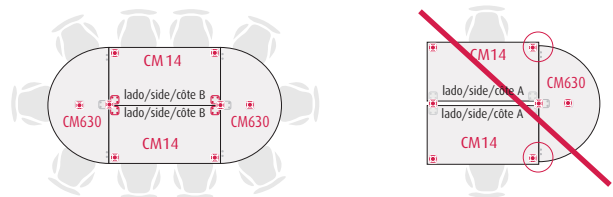

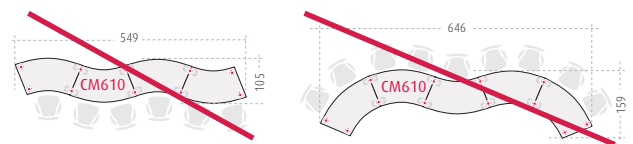

CM610, CM620 and CM632 must be only used in "U" and round shape configurations. It is not possible to do organic shape configurations shown in the picture.





MOBILE STORAGE PEDESTAL

MODELS AND SIZES	STRUCTURE	REFERENCES	WHITE	MAPLE	LIGHT OAK	ELM	WALNUT-N	PACKAGING (packs - vol. - weight)
<b>J90</b>  <p>Mobile pedestal 80 x 53 x 58 cm                      1 heigh adjustable shelf                      1 drawer with lock                      1 filing frame                      1 pencil tray and divider</p>	ALL ONE FINISH	<b>J90--</b>	277,20	277,20	277,20	277,20	277,20	Nº Packs: 1 Vol.: 0,215 m3 Weight: 30,5 kg

MOBILE PEDESTALS WITH METAL RUNNERS

MODELS AND SIZES	STRUCTURE	REFERENCES	WHITE	MAPLE	LIGHT OAK	ELM	WALNUT-N	PACKAGING (packs - vol. - weight)
<b>J132</b>  <p>3 drawers.</p>	ALL ONE FINISH	<b>J132--</b>	211,40	211,40	211,40	211,40	211,40	Nº Packs: 1 Vol.: 0,1523 m3 Weight: 19 kg
<b>J133</b>  <p>1 drawer. 1 filing frame.</p>	ALL ONE FINISH	<b>J133--</b>	218,40	218,40	218,40	218,40	218,40	Nº Packs: 1 Vol.: 0,1523 m3 Weight: 17 kg

MOBILE PEDESTAL WITH METAL RUNNERS WITH WHEELS

MODELS AND SIZES	STRUCTURE	REFERENCES	WHITE	MAPLE	LIGHT OAK	ELM	WALNUT-N	PACKAGING (packs - vol. - weight)
<b>J832</b>  <p>3 drawers.</p>	ALL ONE FINISH	<b>J832--</b>	175,00	175,00	175,00	175,00	175,00	Nº Packs: 1 Vol.: 0,1523 m3 Weight: 20 kg
<b>J840</b>  <p>1 drawer. 1 filing drawer.</p>	ALL ONE FINISH	<b>J840--</b>	176,40	176,40	176,40	176,40	176,40	Nº Packs: 1 Vol.: 0,1523 m3 Weight: 20 kg

Please check on the pedestals range for all available finishes.

COOL MODESTY PANEL

MODEL AND SIZES	WIDTH	FINISHES	WHITE	SILVER	R.R.P.	PACKAGING (packs · vol. · weight)
 <p>STEEL MODESTY PANEL</p>	74 For 120 cm desks	MFC	<b>FC13300</b>	<b>FC13302</b>	54,60	1 Packs · 0,0176 m3 · 4 kg
		STEEL	<b>FC12300</b>	<b>FC12302</b>	107,80	1 Packs · 0,0176 m3 · 4 kg
 <p>MFC MODESTY PANEL</p>	98 For 140 cm desks	MFC	<b>FC13400</b>	<b>FC13402</b>	57,40	1 Packs · 0,0209 m3 · 4,5 kg
		STEEL	<b>FC12400</b>	<b>FC12402</b>	110,60	1 Packs · 0,0209 m3 · 4,5 kg
	118 For 160 cm desks	MFC	<b>FC13500</b>	<b>FC13502</b>	60,20	1 Packs · 0,024 m3 · 5 kg
		STEEL	<b>FC12500</b>	<b>FC12502</b>	114,80	1 Packs · 0,024 m3 · 5 kg
	138 For 180 and 200 cm desks	MFC	<b>FC13600</b>	<b>FC13602</b>	63,00	1 Packs · 0,0274 m3 · 5,5 kg
		STEEL	<b>FC12600</b>	<b>FC12602</b>	126,00	1 Packs · 0,0274 m3 · 5,5 kg

DESK PAD - TAP MANAGER

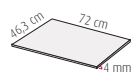

- Protects your desktop from scratches, stains and spills.
- Ergonomic surface enables smoother writing for improved penmanship.
- Made from all natural anti-bacterial materials.
- Provides a non-glare, non-skid, anti-static dust-repelling surface.
- Mouse pad not needed

MODELS AND SIZES	FINISHES	REFERENCES	R.R.P.
  <p>Recommended for Glass Top Poliuretane Pad</p>	BLACK	<b>PAD59</b>	61,60
	RED	<b>PAD57</b>	

CPU HOLDER

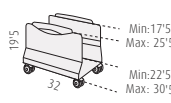

The mobile CPU Holder can be used on any desking system

MODEL AND SIZES	WHITE	SILVER	R.R.P. UNIT:	PACKAGING (packs · vol. · weight)
 <p>Mobile CPU holder.</p>	<b>396040</b>	<b>39604</b>	67,20	3 Kg. Vol: 0,0214 m3 Nº Packs: 1
 <p><b>COOL R200/C400/C500</b> Steel adjustable ATX CPU holder. Width adjustment from 14 to 22cm</p>	<b>505060</b>	<b>50506</b>	98,00	1 Packs · 0,0045 m3 · 0,4 kg
 <p><b>COOL R200/C400/C500</b> Steel adjustable SLIM CPU holder. Width adjustment from 9 to 22cm</p>	<b>505070</b>	<b>50507</b>	86,80	1 Packs · 0,0045 m3 · 0,4 kg

**CABLE TRAY**

MODEL AND SIZES	LENGHT	WHITE	SILVER	R.R.P. UNIT	PACKAGING (packs · vol. · weight)
Individual cable tray 	For 120 cm desks	<b>45000</b>	<b>45002</b>	56,00	1 Pack · 0,009 m3 · 2,1 kg
	For 140 cm desks	<b>45100</b>	<b>45102</b>	61,60	1 Pack · 0,009 m3 · 2,6 kg
	For 160 cm desks	<b>45120</b>	<b>45122</b>	67,20	1 Pack · 0,012 m3 · 3,2 kg
	For 180 cm or 200 cm desks	<b>45140</b>	<b>45142</b>	71,40	1 Pack · 0,014 m3 · 3,7 kg

**CABLE SPINE (POLYSTYRENE)**

MODEL AND SIZES	SILVER	R.R.P. UNIT	PACKAGING (packs · vol. · peso)
 cable spine (kit 3 units, 80cms, height)	<b>39525</b>	18,20	N° Packs: 1 Vol.: 0,0045 m3 Weight: 0,4 kg

**ELECTRIFICATION**



COOL C400 has available an individual cable riser easy to fix to the leg.

MODEL AND SIZES	PACK UNITS	REFERENCES	R.R.P. PACK	PACKAGING (packs · vol. · weight)
<b>CCX10</b>  Cable riser for COOL C400 (6 modules per unit)	Pack 4 Units	<b>CCX10</b>	19,60	1 Packs · 0,013 m3 · 1,8 kg

**LARGE CAPACITY CABLE TRAY**

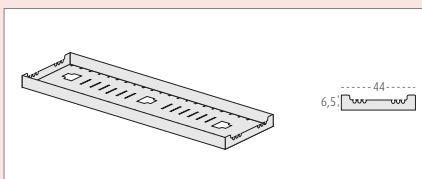

**METAL CABLE SPINE**

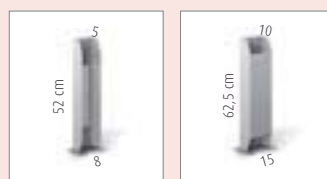

Actiu offers the possibility to produce large capacity cable trays adapted to Cool C500 for projects as well as Metal cable spines. Please check price and offer with our sales team.



**SERIE D80 - SCREENS FOR INDIVIDUAL USE ONLY**

**SERIE D80** is only available for **INDIVIDUAL USE**. Fixed to the front of side of the desk. Depending on the finish as well as 2 different heights.

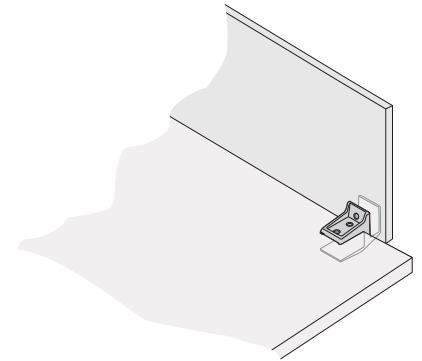
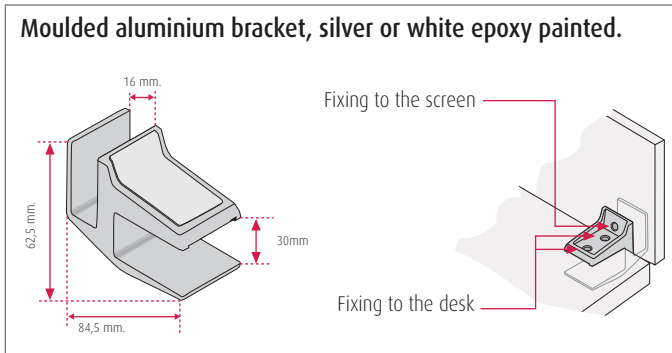

**MODELS AND SIZES:**

**• 33 cm Screens**

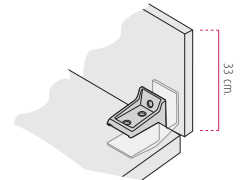

**• 28 cm Screens**

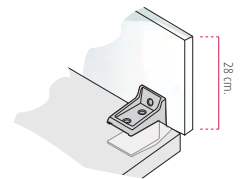
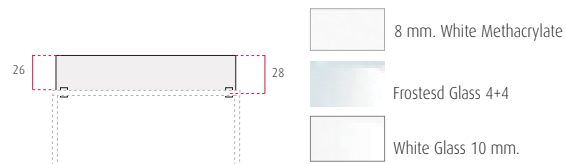

## FINISH CODE

To order a product, you will have to complete the reference with the **finish code** replacing the two hyphens by the finish you need. Finishes available will be shown in the column price.

Sample: DC811-- SILVER MFC will be --> DC81102

WHITE MFC	SILVER MFC	FABRIC T	FABRIC M	FABRIC F	METHACRYLATE	FROSTED GLASS	WHITE GLASS
00	02	T--	M--	F--	90	50	52

## HOW TO ORDER BRACKETS IN WHITE FINISH

To order screens with WHITE FINISH BRACKETS (to be used on white frame desks) you have to add a B at the end of the reference.

Sample: Pack of 2 screens 110x33 cm (pack 2 units) - **DC83--**

Silver MFC finish: **02**

Brackets in white finish: **B**







} **DC83202B**

## SERIE D80 - SCREENS FOR INDIVIDUAL USE ONLY

### SCREENS 33 cm. HEIGHT

MODEL AND SIZES	DESK WIDTH	UNITS/PACK	REFERENCES	WHITE MFC	SILVER MFC	FABRIC T	FABRIC M	FABRIC F	PACKAGING (packs · vol. · weight)
	80	Pack 1 Unit	<b>DC811--</b>	47,60	47,60	67,20	85,40	91,00	Pack 1 Unit: 3 Kg. · Vol: 0,0191 m3 Nº Packs: 1
		Pack 2 Units	<b>DC812--</b>	88,20	88,20	126,00	162,40	173,60	Pack 2 Units: 5 Kg. · Vol: 0,0191 m3 Nº Packs: 1
	100	Pack 1 Unit	<b>DC821--</b>	51,80	51,80	72,80	96,60	103,60	Pack 1 Unit: 4,5 Kg. · Vol: 0,023 m3 Nº Packs: 1
		Pack 2 Units	<b>DC822--</b>	89,60	89,60	133,00	180,60	194,60	Pack 2 Units: 8 Kg. · Vol: 0,023 m3 Nº Packs: 1
	120	Pack 1 Unit	<b>DC831--</b>	56,00	56,00	79,80	107,80	116,20	Pack 1 Unit: 4,5 Kg. · Vol: 0,0267 m3 Nº Packs: 1
		Pack 2 Units	<b>DC832--</b>	96,60	96,60	148,40	204,40	221,20	Pack 2 Units: 8 Kg. · Vol: 0,0267 m3 Nº Packs: 1
	140	Pack 1 Unit	<b>DC841--</b>	58,80	58,80	88,20	120,40	130,20	Pack 1 Unit: 5 Kg. · Vol: 0,0387 m3 Nº Packs: 1
		Pack 2 Units	<b>DC842--</b>	103,60	103,60	165,20	229,60	249,20	Pack 2 Units: 9,5 Kg. · Vol: 0,0387 m3 Nº Packs: 1
	160	Pack 1 Unit	<b>DC851--</b>	63,00	63,00	96,60	133,00	144,20	Pack 1 Unit: 6 Kg. · Vol: 0,0387 m3 Nº Packs: 1s: 1
		Pack 2 Units	<b>DC852--</b>	114,80	114,80	180,60	253,40	275,80	Pack 2 Units: 11 Kg. · Vol: 0,0387 m3 Nº Packs: 1
	180	Pack 1 Unit	<b>DC861--</b>	68,60	68,60	105,00	145,60	159,60	Pack 1 Unit: 7 Kg. · Vol: 0,043 m3 Nº Packs: 1
		Pack 2 Units	<b>DC862--</b>	126,00	126,00	197,40	278,60	306,60	Pack 2 Units: 12,5 Kg. · Vol: 0,043 m3 Nº Packs: 1

## SCREENS 28 cm. HEIGHT

MODEL AND SIZES	DESK WIDTH	BRACKET	UNITS/PACK	REFERENCES	METHACRYLATE	FROSTED GLASS	WHITE GLASS	PACKAGING (packs · vol. · weight)
								
<b>D81</b> 	80	ALUMINIUM	Pack 1 Unit	<b>DC81128--</b>	71,40	119,00	126,00	Pack 1 Unit Acrylic: 2 Kg. Glass: 4'5 Kg. Vol: 0,0191 m <sup>3</sup> Nº Packs: 1
			Pack 2 Units	<b>DC81228--</b>	133,00	226,80	240,80	Pack 2 Units Acrylic: 5 Kg. Glass: 8'5 Kg. Vol: 0,0191 m <sup>3</sup> Nº Packs: 1
<b>D82</b> 	100	ALUMINIUM	Pack 1 Unit	<b>DC82128--</b>	82,60	133,00	141,40	Pack 1 Unit Acrylic: 3 Kg. Glass: 5 Kg. Vol: 0,0191 m <sup>3</sup> Nº Packs: 1
			Pack 2 Units	<b>DC82228--</b>	158,20	253,40	270,20	Pack 2 Units Acrylic: 5 Kg. Glass: 10'5 Kg. Vol: 0,0191 m <sup>3</sup> Nº Packs: 1
<b>D83</b> 	120	ALUMINIUM	Pack 1 Unit	<b>DC83128--</b>	98,00	159,60	180,60	Pack 1 Unit Acrylic: 3'5 Kg. Glass: 10 Kg. Vol: 0,0267 m <sup>3</sup> Nº Packs: 1
			Pack 2 Units	<b>DC83228--</b>	186,20	308,00	330,40	Pack 2 Units Acrylic: 6 Kg. Glass: 16 Kg. Vol: 0,0267 m <sup>3</sup> Nº Packs: 1
<b>D84</b> 	140	ALUMINIUM	Pack 1 Unit	<b>DC84128--</b>	110,60	175,00	203,00	Pack 1 Unit Acrylic: 4 Kg. Glass: 11'5 Kg. Vol: 0,0307 m <sup>3</sup> Nº Packs: 1
			Pack 2 Units	<b>DC84228--</b>	211,40	337,40	369,60	Pack 2 Units Acrylic: 7 Kg. Glass: 18'5 Kg. Vol: 0,0307 m <sup>3</sup> Nº Packs: 1
<b>D85</b> 	160	ALUMINIUM	Pack 1 Unit	<b>DC85128--</b>	124,60	190,40	219,80	Pack 1 Unit Acrylic: 4'5 Kg. Glass: 13 Kg. Vol: 0,0387 m <sup>3</sup> Nº Packs: 1
			Pack 2 Units	<b>DC85228--</b>	236,60	364,00	406,00	Pack 2 Units Acrylic: 8 Kg. Glass: 21 Kg. Vol: 0,0387 m <sup>3</sup> Nº Packs: 1
<b>D86</b> 	180	ALUMINIUM	Pack 1 Unit	<b>DC86128--</b>	142,80	217,00	250,60	Pack 1 Unit Acrylic: 5 Kg. Glass: 14 Kg. Vol: 0,043 m <sup>3</sup> Nº Packs: 1
			Pack 2 Units	<b>DC86228--</b>	275,80	417,20	463,40	Pack 2 Units Acrylic: 9 Kg. Glass: 25'5 Kg. Vol: 0,043 m <sup>3</sup> Nº Packs: 1

**SERIE D20 - SCREENS FOR TWIN DESKS**

Moulded aluminium bracket, silver or white epoxy painted.

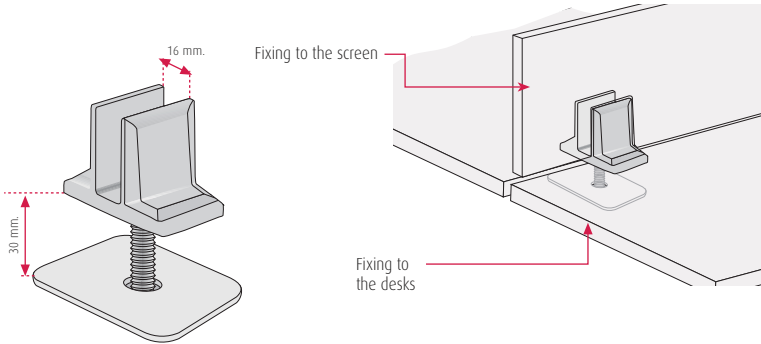

**RANGES WHERE THIS BRACKET STYLE CAN BE USED:**  
COOL C500: Twin desks (Back to back use)

SERIE D20 is available for TWIN DESKS. It is fixed back to back with a bracket. Three different heights depending on the finish.

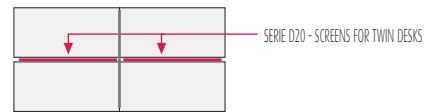
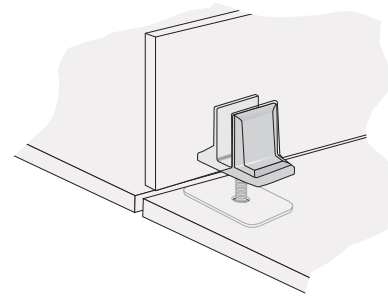



**MODELS AND SIZES:**

**• 33 cm Screens**



-  16 mm MFC
-  16 mm MFC

-  16 mm Upholstered MFC board - Group F
-  16 mm Upholstered MFC board - Group M
-  16 mm Upholstered MFC board - Group T

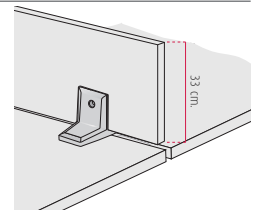

**• 28 cm Screens**

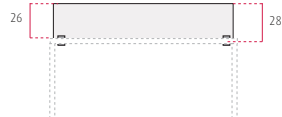

-  8 mm. White Methacrylate
-  Frosted Glass 4+4
-  White Glass 10 mm.

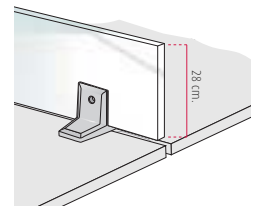

## FINISH CODE

To order a product, you will have to complete the reference with the **finish code** replacing the two hyphens by the finish you need. Finishes available will be shown in the column price.  
 Sample: DC241-- SILVER MFC will be --> DC24102

WHITE MFC	SILVER MFC	FABRIC T	FABRIC M	FABRIC F	METHACRYLATE	FROSTED GLASS	WHITE GLASS
00	02	T--	M--	F--	90	50	52

## HOW TO ORDER BRACKETS IN WHITE FINISH

To order screens with WHITE FINISH BRACKETS (to be used on white frame desks) you have to add a B at the end of the reference.

Sample: Pack of 2 screens 130x33 cm (pack 2 units) - **DC242--**

Silver MFC finish: **02**

**Brackets in white finish: B**

**DC24202B**

## SCREENS 33 cm.

MODEL AND SIZES	DESK WIDTH	UNITS/PACK	REFERENCES	WHITE MFC	SILVER MFC	FABRIC T	FABRIC F	FABRIC M	PACKAGING (packs · vol. · weight)
<b>D24</b> 	140	Pack 1 Unit	<b>DC241--</b>	57,40	57,40	88,20	120,40	130,20	5 Kg. · Vol: 0,0387 m3
		Pack 2 Units	<b>DC242--</b>	102,20	102,20	163,80	228,20	247,80	9,5 Kg. · Vol: 0,0387 m3
<b>D25</b> 	160	Pack 1 Unit	<b>DC251--</b>	61,60	61,60	96,60	133,00	144,20	6 Kg. · Vol: 0,0387 m3
		Pack 2 Units	<b>DC252--</b>	110,60	110,60	182,00	254,80	277,20	11 Kg. · Vol: 0,0387 m3
<b>D26</b> 	180	Pack 1 Unit	<b>DC261--</b>	67,20	67,20	105,00	145,60	159,60	7 Kg. · Vol: 0,043 m3
		Pack 2 Units	<b>DC262--</b>	123,20	123,20	198,80	280,00	308,00	12,5 Kg. · Vol: 0,043 m3

## SCREENS 28 cm. HEIGHT

MODEL AND SIZES	DESK WIDTH	UNITS/PACK	REFERENCES	METHACRYLATE	FROSTED GLASS	WHITE GLASS	PACKAGING (packs · vol. · weight)
<b>D24</b> 	140	Pack 1 Unit	<b>DC24281--</b>	112,00	172,20	199,50	Pack 1 Unit Acrylic: 4 Kg. Glass: 11,5 Kg. Vol: 0,0307 m3
		Pack 2 Units	<b>DC24282--</b>	215,60	333,20	362,60	Pack 2 Units Acrylic: 7 Kg. Glass: 18,5 Kg. Vol: 0,0307 m3
<b>D25</b> 	160	Pack 1 Unit	<b>DC25281--</b>	124,60	189,00	217,00	Pack 1 Unit Acrylic: 4,5 Kg. Glass: 13 Kg. Vol: 0,0387 m3
		Pack 2 Units	<b>DC25282--</b>	240,80	365,40	404,60	Pack 2 Units Acrylic: 8 Kg. Glass: 21 Kg. Vol: 0,0387 m3
<b>D26</b> 	180	Pack 1 Unit	<b>DC26281--</b>	144,20	210,00	245,00	Pack 1 Unit Acrylic: 5 Kg. Glass: 14 Kg. Vol: 0,043 m3
		Pack 2 Units	<b>DC26282--</b>	280,00	408,80	453,60	Pack 2 Units Acrylic: 9 Kg. Glass: 25,5 Kg. Vol: 0,043 m3

**SERIE D70 - SCREENS FOR PROGRESSIVE DESKS (Side by side use)**

Moulded aluminium bracket, silver or white epoxy painted.

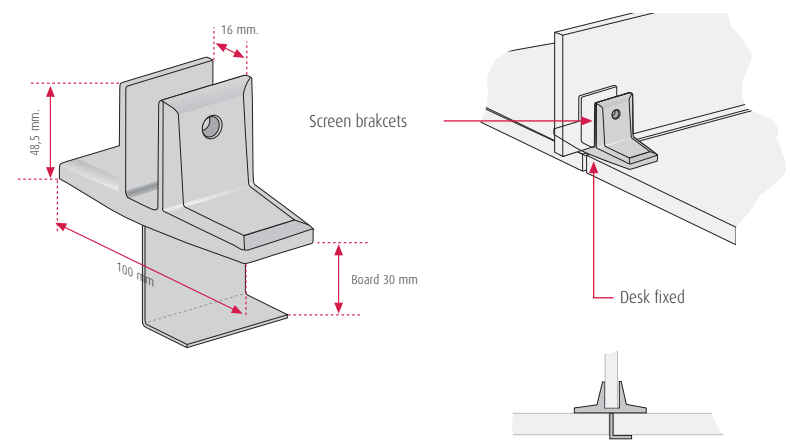

**AVAILABLE FOR:**  
COOL C500: MFC and HPL

SERIE D70 is available only for PROGRESSIVE DESKS.  
Two different heights depending on the screen finish.

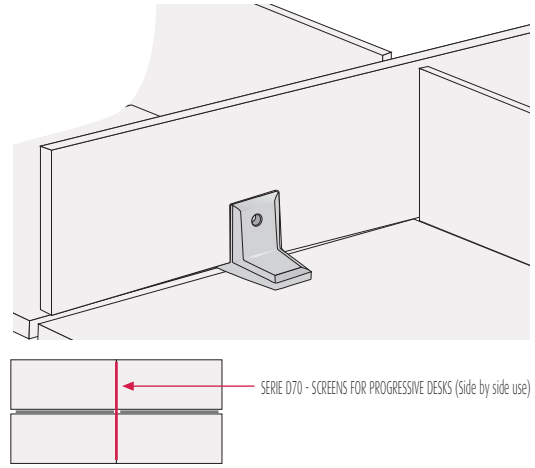

**MODELS AND SIZES:**

**• 30 cm Screens**

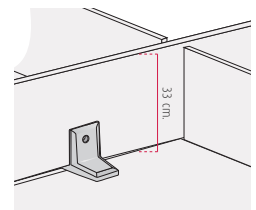

**• 25 cm Screens**

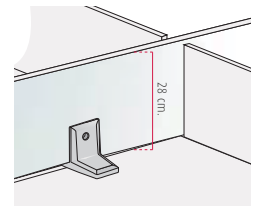
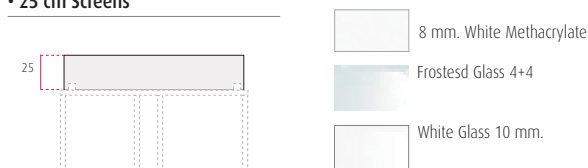

## FINISH CODE

To order a product, you will have to complete the reference with the **finish code** replacing the two hyphens by the finish you need.

Finishes available will be shown in the column price.

Sample: DC711-- SILVER MFC will be --> DC71102

WHITE MFC	SILVER MFC	FABRIC T	FABRIC M	FABRIC F	METHACRYLATE	FROSTED GLASS	WHITE GLASS
00	02	T--	M--	F--	90	50	52

## HOW TO ORDER BRACKETS IN WHITE FINISH

To order screens with WHITE FINISH BRACKETS (to be used on white frame desks) you have to add a B at the end of the reference.

Sample: Pack of 2 screens 110x33 cm (pack 2 units) - **DC732--**

Silver MFC finish: **02**

Brackets in white finish: B

**DC73202B**

## SCREENS 30 cm. HEIGHT

MODEL AND SIZES	DESK WIDTH	UNITS/PACK	REFERENCES	WHITE MFC	SILVER MFC	PACKAGING (packs · vol. · weight)
<b>D71</b> 	80	Pack 1 Unit	<b>DC711--</b>	46,20	46,20	Pack 1 Unit 5 Kg. · Vol: 0,0387 m <sup>3</sup> N° Packs: 1
		Pack 2 Units	<b>DC712--</b>	85,40	85,40	Pack 2 Units 9,5 Kg. · Vol: 0,0387 m <sup>3</sup> N° Packs: 1
<b>D73</b> 	120	Pack 1 Unit	<b>DC731--</b>	54,60	54,60	Pack 1 Unit 5 Kg. · Vol: 0,0387 m <sup>3</sup> N° Packs: 1
		Pack 2 Units	<b>DC732--</b>	98,00	98,00	Pack 2 Units 9,5 Kg. · Vol: 0,0387 m <sup>3</sup> N° Packs: 1
<b>D75</b> 	160	Pack 1 Unit	<b>DC751--</b>	61,60	61,60	Pack 1 Unit 5 Kg. · Vol: 0,0387 m <sup>3</sup> N° Packs: 1
		Pack 2 Units	<b>DC752--</b>	114,80	114,80	Pack 2 Units 9,5 Kg. · Vol: 0,0387 m <sup>3</sup> N° Packs: 1
<b>D79</b> 		Pack 2 Units	<b>DC792--</b>	58,80	58,80	9,5 Kg. · Vol: 0,0387 m <sup>3</sup> N° Packs: 1

## SCREENS 25 cm. HEIGHT

MODEL AND SIZES	DESK WIDTH	UNITS/PACK	REFERENCES	METHACRYLATE	FROSTED GLASS	WHITE GLASS	PACKAGING (packs · vol. · weight)
<b>D71</b> 	80	Pack 1 Unit	<b>DC71128--</b>	67,20	107,80	116,20	Pack 1 Unit Acrylic: 4 Kg. Glass: 11,5 Kg. Vol: 0,0307 m <sup>3</sup>
		Pack 2 Units	<b>DC71228--</b>	126,00	205,80	221,20	Pack 2 Units Acrylic: 7 Kg. Glass: 18,5 Kg. Vol: 0,0307 m <sup>3</sup>
<b>D73</b> 	120	Pack 1 Unit	<b>DC73128--</b>	93,80	152,60	175,00	Pack 1 Unit Acrylic: 4,5 Kg. Glass: 13 Kg. Vol: 0,0387 m <sup>3</sup>
		Pack 2 Units	<b>DC73228--</b>	179,20	291,20	338,80	Pack 2 Units Acrylic: 8 Kg. Glass: 21 Kg. Vol: 0,0387 m <sup>3</sup>
<b>D75</b> 	160	Pack 1 Unit	<b>DC75128--</b>	119,00	190,40	207,20	Pack 1 Unit Acrylic: 5 Kg. Glass: 14 Kg. Vol: 0,043 m <sup>3</sup>
		Pack 2 Units	<b>DC75228--</b>	229,60	368,20	376,60	Pack 2 Units Acrylic: 9 Kg. Glass: 25,5 Kg. Vol: 0,043 m <sup>3</sup>
<b>D79</b> 		Pack 2 Units	<b>DC79228--</b>	85,40	161,00	175,00	Pack 2 Units Acrylic: 9 Kg. Glass: 25,5 Kg. Vol: 0,043 m <sup>3</sup>

## FINISH CODE

To order a product, you will have to complete the reference with the **finish code**, replacing the two hyphens by the finish you need. Finishes available will be showed in the column price.  
 Sample: DSC1041-- White MFC will be DSC104100

FINISHES				
WHITE MFC	SILVER MFC	FABRIC M	FABRIC T	FABRIC F
00	02	M--	T--	F--

## HOW TO ORDER SCREENS IN WHITE FINISH

To order WHITE FINISH SCREENS (to be used on white frame desks) you have to add a B at the end of the reference.

Sample: Pack of 2 screens 140x41 cm: - **DSC1042--**

White MFC finish : 00

white finish screens: B

**DSC104200B**

## SPLIT DESKTOP SCREENS - BENCH DESKS



Moulded aluminium bracket, silver or white epoxy painted.

**DS10**  
• Single top tool rail

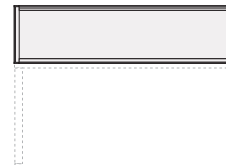

• DS10 -DESKTOP SCREEN WITH TOP SINGLE TOOL RAIL

MODEL AND SIZES	UNITS/PACK	REFERENCES	WHITE MFC	SILVER MFC	FABRIC T	FABRIC F	FABRIC M	PACKAGING (packs · vol. · weight)
<b>DS104</b> 	Pack 1 Unit	<b>DSC1041--</b>	182,00	182,00	186,20	222,60	233,80	10 Kg. Vol.: 0,032 m3 Pack 1 Unit
<b>SPLIT - DS10</b> • Desktop screen for 140 cm. Desks.	Pack 2 Units	<b>DSC1042--</b>	354,20	354,20	362,60	435,40	457,80	19 Kg. Vol.: 0,054 m3 Pack 2 Units
<b>DS105</b> 	Pack 1 Unit	<b>DSC1051--</b>	191,80	191,80	198,80	239,40	253,40	11,5 Kg. Vol.: 0,037 m3 Pack 1 Unit
<b>SPLIT - DS10</b> • Desktop screen for 160 cm. Desks.	Pack 2 Units	<b>DSC1052--</b>	373,80	373,80	389,20	470,40	498,40	21,5 Kg. Vol.: 0,061 m3 Pack 2 Units
<b>DS106</b> 	Pack 1 Unit	<b>DSC1061--</b>	204,40	204,40	212,80	259,00	273,00	13 Kg. Vol.: 0,042 m3 Pack 1 Unit
<b>SPLIT - DS10</b> • Desktop screen for 180 cm. Desks.	Pack 2 Units	<b>DSC1062--</b>	399,00	399,00	415,80	508,20	536,20	24 Kg. Vol.: 0,068 m3 Pack 2 Units



ACTIU has at your disposal a system of Luminarias for individual, twin and progressive desks which can be adapted to the different kind of desks. These screens are fixed to the desk by different brackets and allow making layouts with direct lightning on the work surface. For projects where the use of these Luminaria is needed, please contact Actiu.

**LUMINARIA FOR COLLECTIVITY AND EDUCATIONAL - SERIES 200 (BI-TUBE)**

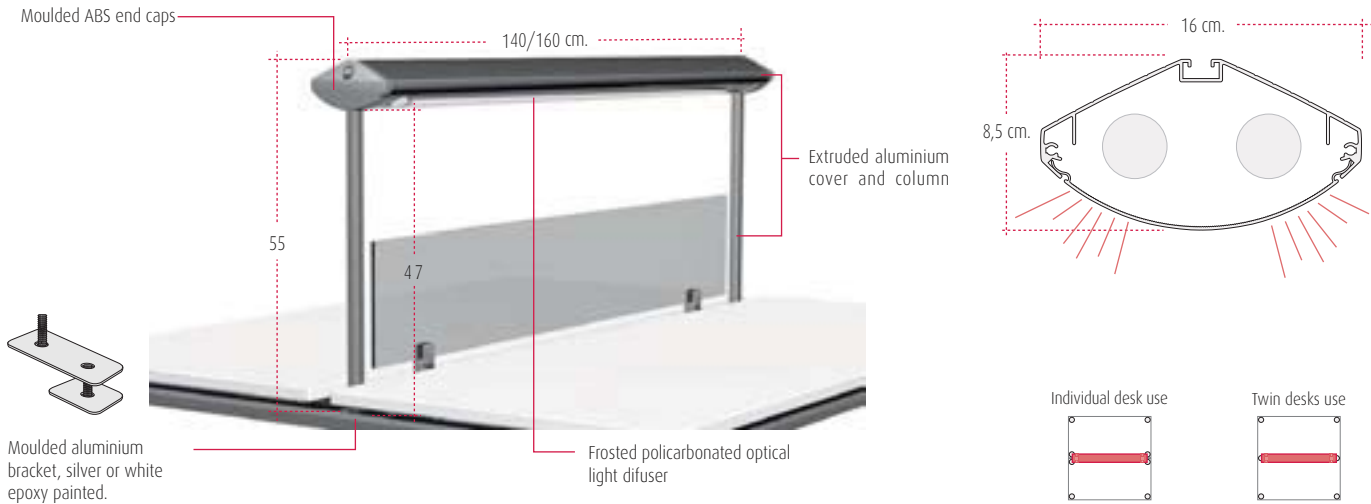

**TECHNICAL FEATURES:**

- Down-light symmetrical light distribution (both sides)
- Flourescent tube reduce loss of heat energy and operate on low wattage. Energy saving upto 20% and increase of life expectancy.
- Head fitted with 2 flourescent tubes 26 mm lenght type T-8 (lighting level depends of the model choosen).
- Flexible power cable type H03VV-F with european plug-in
- Simultaneous switch for all the tubes.

**LUMINARIA FOR COLLECTIVITY AND EDUCATIONAL - SERIES 300 (MONO-TUBE)**

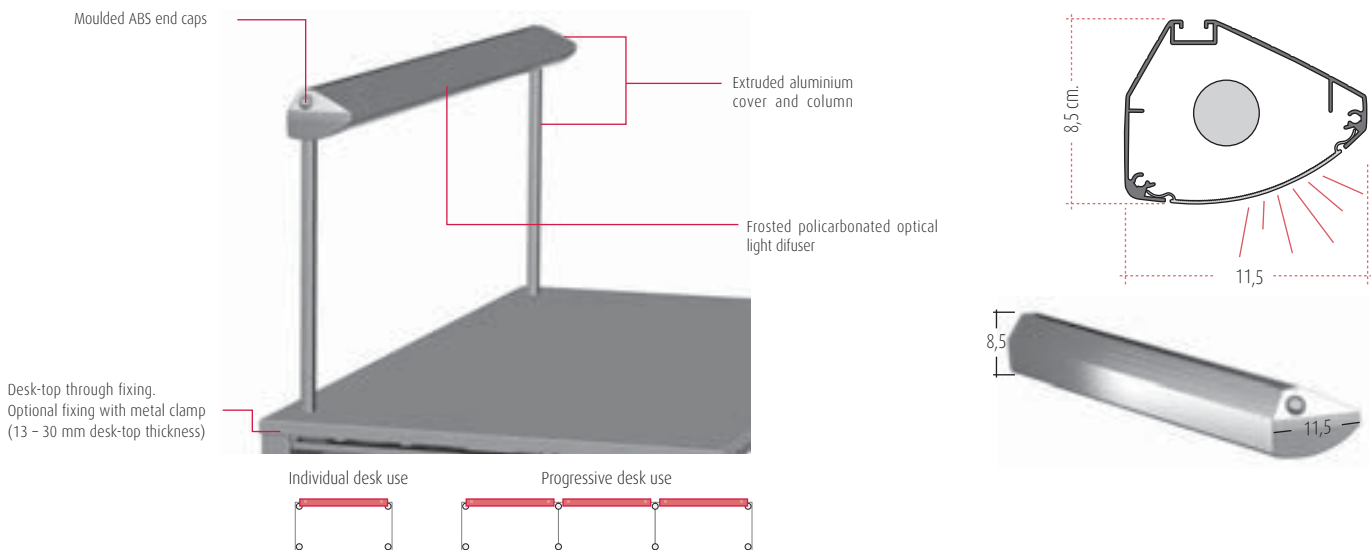

**TECHNICAL FEATURES:**

- Down-light asymmetrical light distribution onto the work surface
- Flourescent tube reduce loss of heat energy and operate on low wattage. Energy saving upto 20% and increase of life expectancy.
- Head fitted with 2 flourescent tubes 26 mm lenght type T-8 (lighting level depends of the model choosen).
- Flexible power cable type H03VV-F with european plug-in
- Simultaneous switch for all the tubes.

Witteveen Projectinrichting  
 Ouderkerk a/d Amstel  
 Tel: 020 - 496 5030  
 info@witteveen.nl  
 www.project-inrichting.nl  
 www.vergadertafel.info

