





## WHAT IS LINK?

The new trends in office design suggest combining privacy with open and collaborative offices, where creativity and communication flow in a natural way. This evolution in the way of understanding work environments lead us to the need to adapt the furniture so that it is flexible and versatile

With this aim, the studio ITEM designworks designed LINK, a modular system which creates and configures spaces of different heights that enables endless design possibilities to adapt work spaces to every need.

'LINK enables you to create new spaces within offices and change them swiftly. It is a light, different program with personality. It works to complement and act as a transition between more individual areas of the office and other more open and collective places. To do this and by means of accessories that make it more operative and dynamic, LINK can combine modular sofas, operative desks and other accessories which expand the possibilities within the office, with the aim to stimulate efficiency of people through comfort and change.' says Javier Cuñado, designer of ITEM designworks.



## WHAT LINK IS COMPOSED OF?



### PANELS

Link PANELS are a modular system for creating spaces from panels of 130 and 170 cm height, with widths of 69, 80 and 102cm. The panels are clad in upholstery in different finishes. The simultaneous composition of panels allows great configuration possibilities.



### JOINTS

The joint system consists of two elements. A superior joint piece and a lower joint piece which also incorporates a leveler. The joints are made of cast aluminum with epoxy paint in black. The joint system is designed to high strength and durability.



### TABLES

The tables, made of melamine board 25mm thickness to configure modulations jobs in both 90 and 120 °. The tables incorporate standard height adjustment system, with a minimum height of 74 cm and 82 cm, divided in 5 positions. In addition, all tables incorporate the new access to wiring "push latch" that allows access to more quickly and conveniently.



### ACCESSORIES

These are made of folded 1.5 mm steel, finished in epoxy paint, textured white with a unique design, optional accessories, allowing higher performance and provides comfort in the workplace.

## 1. LINK PANELS

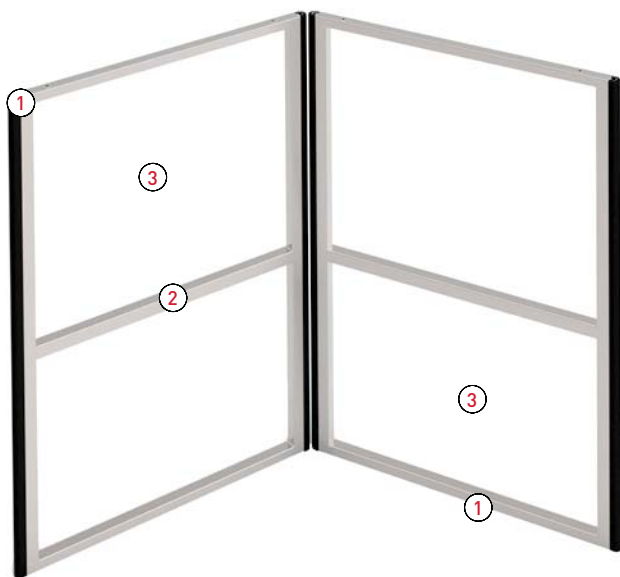

### DESCRIPTION

Metal structure, on which are placed sound-absorbing panels

There are 4 types of panels:

- Finished or extended panel without placement of the table.
- Panel for placement of 1-sided table.
- Panel for placement of 2-sided table with grommets.
- Panel with height change.

### TECHNICAL CHARACTERISTICS

- ① Steel perimeter structure.
- ② Central structure made of steel for elements anchored to the height of the table
- ③ Placement area of absorbing panels 30 mm thick.
- ④ Circular grommets Ø80 mm with access on both sides of the panel.
- ⑤ Cover upholstered in different finishes (See finishes card).

## FINISHES

### GROUP "M" - MELANGE

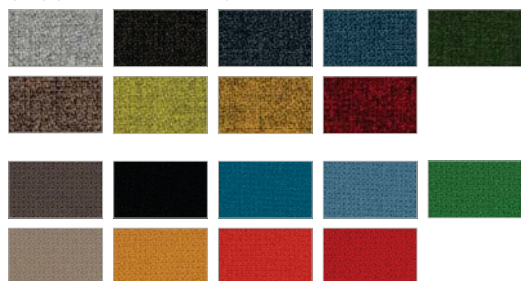

### DESK BOARDS



### JOINTS



### GROUP "B" - BLAZER



### ACCESSORIES



**PANELS. TYPES AND DIMENSIONS**

**END AND GROWTH PANELS**

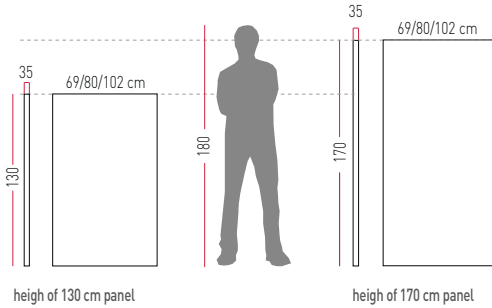

**PANELS FOR CHANGE OF HEIGHT**

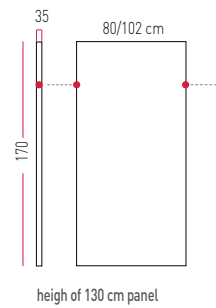

**TYPES OF PANELS:**

- Extendable panels in the same height, 2 heights available:
  - Height of 130 cm.
  - Height of 170 cm.
- Extendable panels with change of height, 1 height available:
  - Height of 170 cm (for changing height to 130 cm)

All Link panels are available in 2 widths:

- Width of 69 cm.
- Width of 80 cm.
- Width of 102 cm.

**LINK PANELS - END AND GROWTH MODULES**

**End and growth modules 130 cm high**

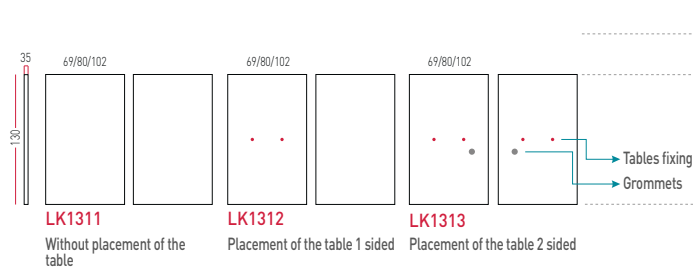

**End and growth modules 170 cm high**

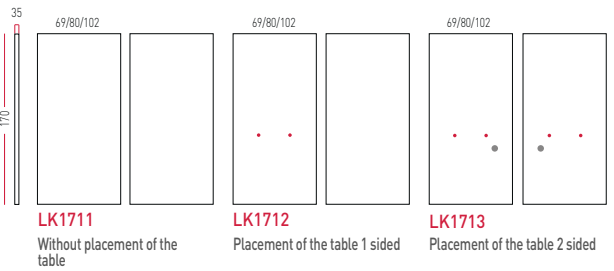

**LINK PANELS - MODULES FOR HEIGHT CHANGE**

**Modules For Height Change - 170 cm high**

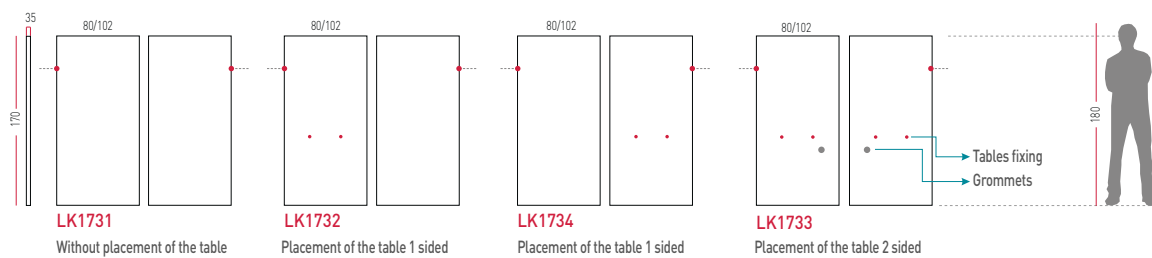

LINK TYPE PANELS

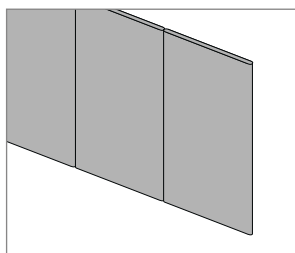

Used icon:

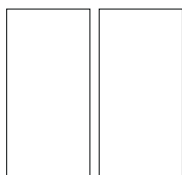

**PANELS WITHOUT ANCHORAGE SYSTEM OF THE TABLE**

Panels that enable the system of anchoring tables from none of its two sides. Available:

- Growth or end panels in 130 cm or 170 cm height.
- Panels to change from 170cm height.

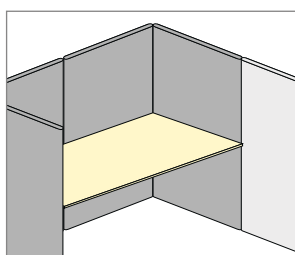

Used icon:

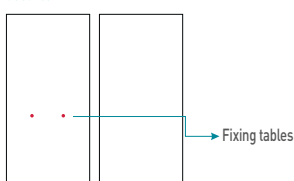

**PANELS WITH THE PLACEMENT OF THE TABLE ON ONE SIDE**

Panels that enable the system of anchoring tables on one side. The other side doesn't have the anchorage system.

- Growth or end panels in 130 cm or 170 cm height.
- Panels to change from 170 cm height.

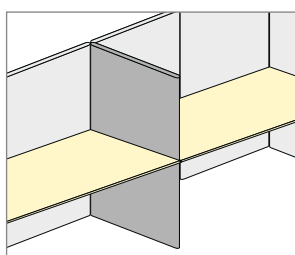

Used icon:

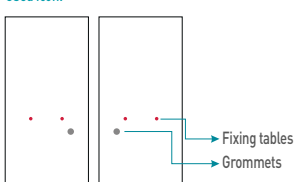

**PANELS WITH THE PLACEMENT OF THE TABLE ON TWO SIDES**

Panels that enable the system of anchoring tables on two sides

- Growth or end panels in 130 cm or 170 cm height.
- Panels to change from 170cm height.

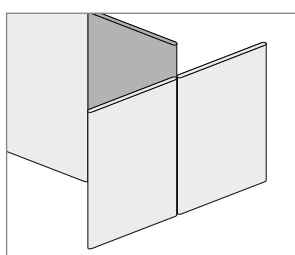

Used icon:

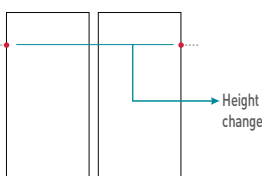

**PANELS WITH A HEIGHT CHANGE (Always at 90°)**

Panels of 170 cm height, which enables height changes in combinations with panels of 130 cm height. Availability:

- Panels of 170 cm without an anchorage system of a table.
- Panels of 170 cm height with an anchorage system of a table on 1 side.
- Panels of 170 cm height with an anchorage system of a table on 2 sides.

## ■ ACOUSTICS

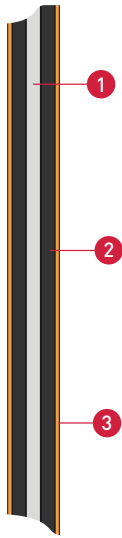

- ① 10 mm thick **Chipboard**
- ② **Foam** thickness  $e = 10$  mm and  $60 \text{ Kg/m}^3$  ( $e_{\text{total}} = 40$  mm) density
- ③ **decorative fabric** adhesives with glue to water
  - Possibility of sound **proofing and/or fireproof fabrics**, optional for projects

Actiu upholstered Index		
● GROUP "B"	BLAZER	Good sound absorption
● GROUP "M"	MELANGE	Average sound absorption M1 fire

- Finishes offered in Price List

### CAUSES OF ACOUSTIC DISCOMFORT

**Attitude of the subject.** Of its acceptability or not.

#### Physical characteristics of noise

- **Types of tones.** Pure tones (those that do not vary in frequency) more annoying than the compounds. Even more when aired on audible frequencies (500 – 2000 Hz)
- **Frequency.** More annoying high frequencies than low ones.
- **Randomness.** The variation in noise annoyance increases.

**Non physical characteristics.** Most annoying noise the less predictable.

**Type of activity.** Greater discomfort the greater need of concentration.

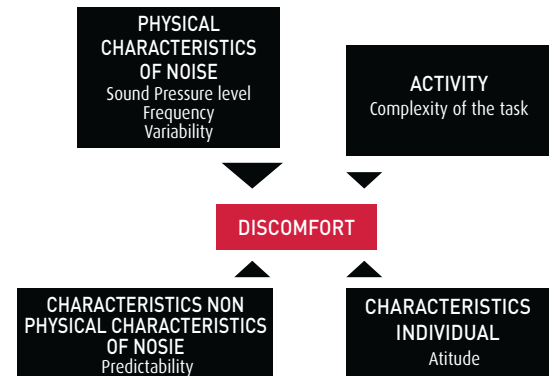

### ACOUSTIC ERGONOMICS AND COMFORT

Acoustic comfort is the sound level that does not disturb or bother or cause any harm direct to health.

#### ORIGIN OF ACOUSTIC DISCOMFORT

- eam working and equipment: photocopiers, CPU's, air conditioning, telephones...
- Open offices poorly designed with overstaffing
- External noise due to poor insulation of the building

#### CONTROL MEASURES

Controlling noise within teams

- Install printers and faxes in remote rooms and areas
- Using silent office equipment, by adding insulated housing
- Lower the intensity of telephones and communication devices
- Use doors with spring systems....

Control the noise within ventilation and air conditioning

Avoid noise transmission between units using insulating the walls

En el medio de propagación se recomienda:

- Place sound absorbing materials in the walls, ceilings and floors
- Surfaces that do not reflect too much. (Reverbatation Time  $\leq 1$  seg)
- Place absorbent panels between desks and workstations
- Provide office furniture that improves the acoustic behaviour of space, hollow ceilings, carpeted floor, upholstered chairs....
- Respect the local occupancy according to its volumen and its use
- Achieve quiet habits of conduct and communication

The graphics and image show how the panels, using Snowsound® technology, affect the acoustics of a room:

- 1 Notwithstanding the reduced thickness they do relatively well in absorbing the low frequencies (below 500 Hz), those that characterise deep sounds that are normally more difficult to dampen;
- 2 They absorb very well the midrange frequencies (between 500 and 2,000 Hz), those typical of the human voice and generally in all workplaces;
- 3 They tend to reflect, gradually absorbing less of the high frequencies (above 2,000 Hz), those which by their nature are already in large part absorbed by the walls, the furnishings and by the very presence of people. The result thus obtained is a comprehensive, natural balance of sounds in the environment.

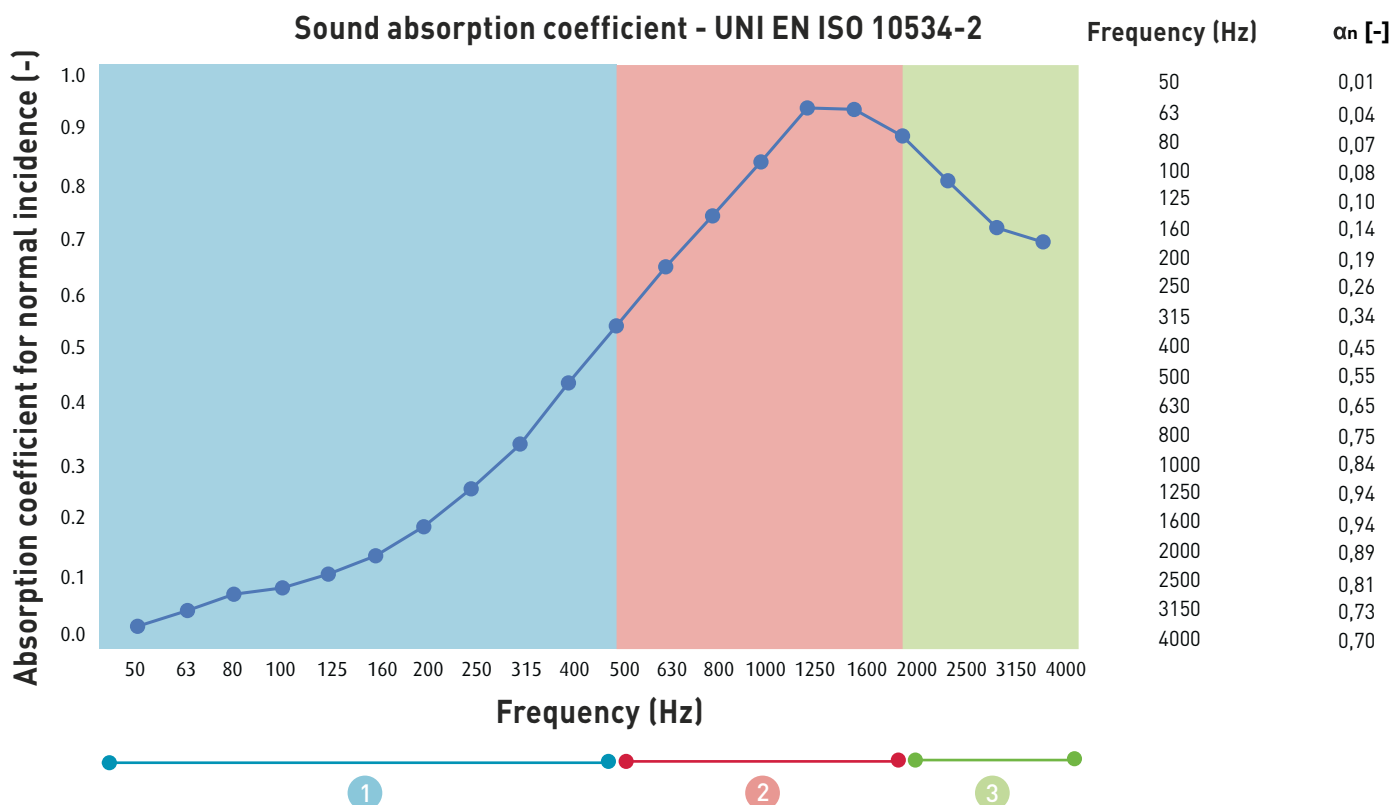
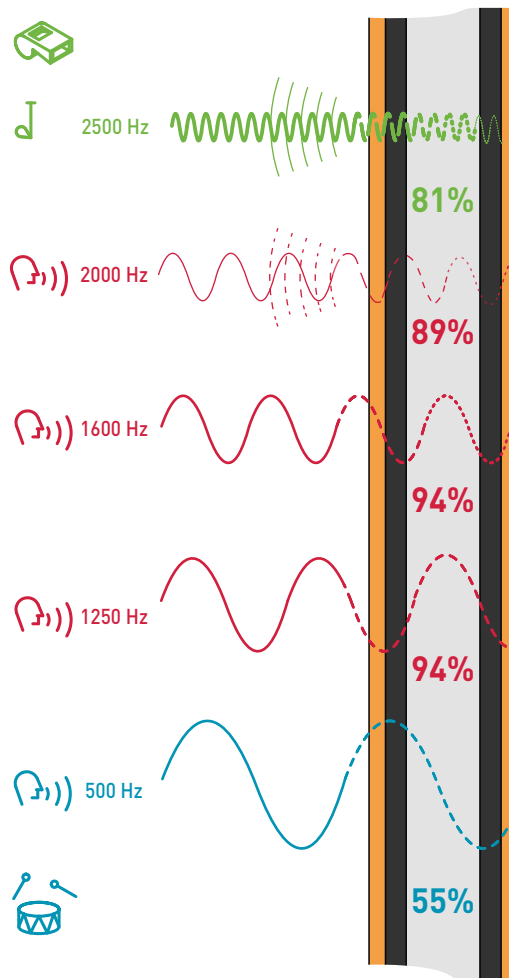

The sound absorption coefficient for normal incidence was calculated in Kundt's tube prepared according to the standard UNI EN ISO 10534-2, test executed by Materiacustica, a spin-off company of the University of Ferrara.

## 2. SYSTEMS OF LINK JOINTS

The joint system consists of two elements. A superior joint piece and a bottom piece which also incorporates an leveler. The joints are made of cast aluminum painted with black epoxy. The joint system is designed to obtain high strength, durability and structural fixation



Superior joining piece



Lower joining piece

### TWO TYPES OF JOINTS

Pieces for joining panels of the **same height**.

Pieces for joining panels of **different heights**.

### ANCHORAGE SYSTEMS FOR CONFIGURATIONS OF THE SAME HEIGHT

**LK61**  
Progressive straight line pack - 2 modules

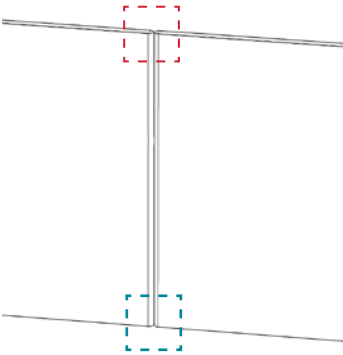
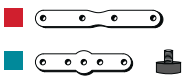

**LK41**  
Progressive angle of 90° pack - 2 modules

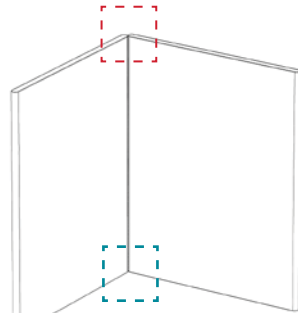

**LK51**  
Progressive angle of 120° pack - 2 modules

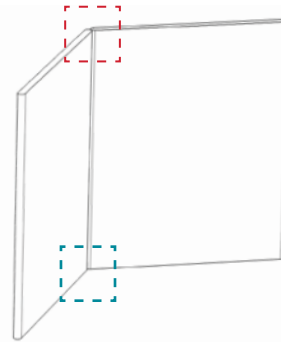

**LK31**  
Progressive pack for "T" joint - 3 Modules

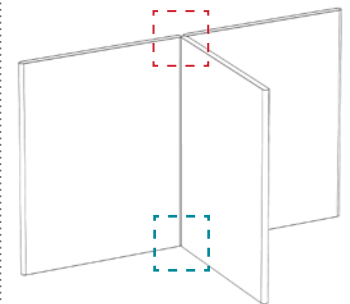

**LK11**  
Progressive pack for "Y" joint - 3 Modules

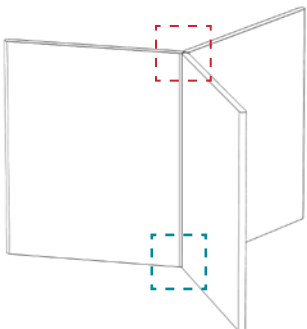
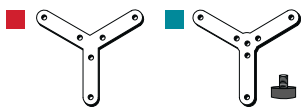

**LK21**  
Progressive pack for 4 panels of 90° - 4 modules

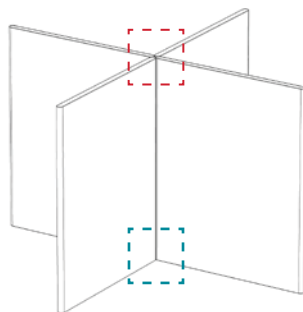
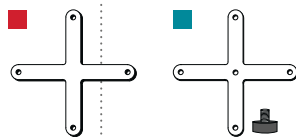

**LK81**  
Extreme end Pack - 1 module

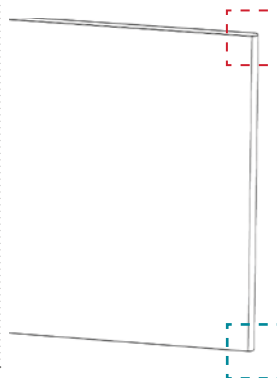
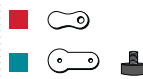

**LK71**  
End pack with 180° rotation - 2 modules

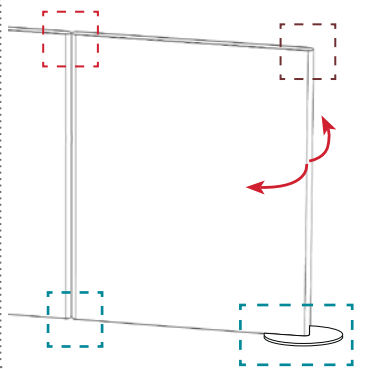



Technical Profile

**LK72**  
Extreme end with fixed feet Pack - 1 module

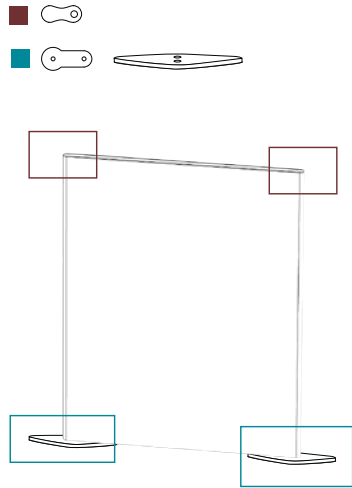

**LK73**  
Progressive straight line with fixed feet pack - 2 modules

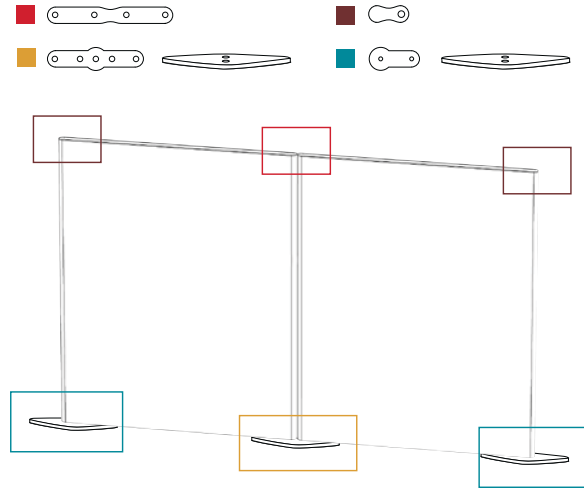

ANCHORAGE SYSTEMS FOR CONFIGURATIONS OF HEIGHT CHANGE

**LK101**  
Progressive pack with a height change with a rotation of 90° - 2 modules. Change of height to the right

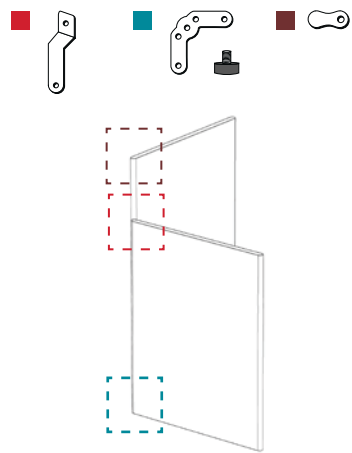

**LK201**  
Progressive pack with a height change with a rotation of 90° - 2 modules. Change of height to the left

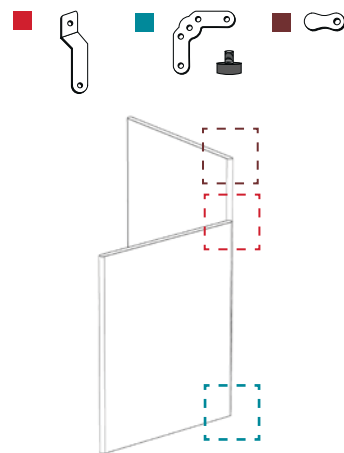

**LK91**  
Progressive pack with a height change with a rotation in "T" - 3 modules.

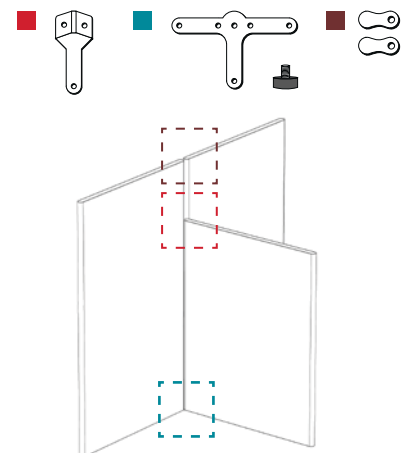

**LK92**  
Progressive pack with a height change with a rotation in "T" - 3 modules

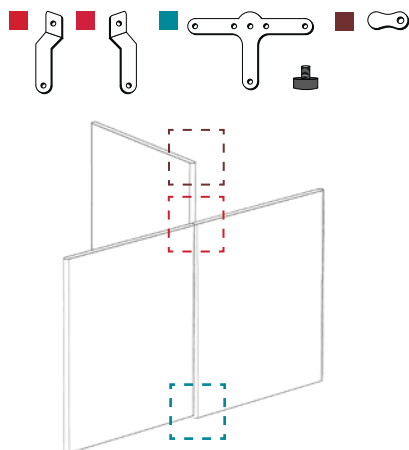

**LK202**  
4 panels with a 90° rotation - 4 modules

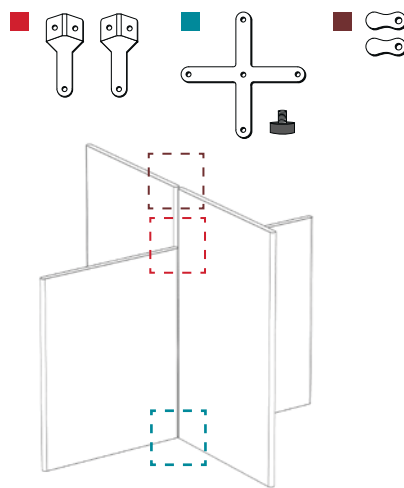

3. WORK DESKS FOR LINK



TABLES

Melamine of 90 and 120 gr. / M2, on chipboard made from certified PEFC 25 mm thickness. PVC edges 2mm thickness, applied with a hot melt glue and rounded R = 2 mm. With high durability and 100% recyclable.



HEIGHT REGULATION

The LINK tables incorporates as standard a system which adjusts mechanical height. It allows the modification of the height of a table from 74 cm to 82 cm in 5 intervals. The system is anchored at 4 points which ensures maximum stability and resistance. The possibility of carrying out a fixed anchorage system for projects exists, please consult with the Commercial Department.



CABLING ACCESS "T"

Access system of cabling with an opening system. "Push-Latch" incorporated as standard on all surfaces. Made from White ABS, it facilitates cable management channels using electrification. It also incorporates an "Anti Dust" system that prevents the accumulation of dust in the wiring. There is the possibility of using other cabling access systems for projects, please consult with the Commercial Department.

TABLES FOR LINK CONFIGURATIONS

Work surfaces for the use of Link with a height adjustment system - Width 60 cm

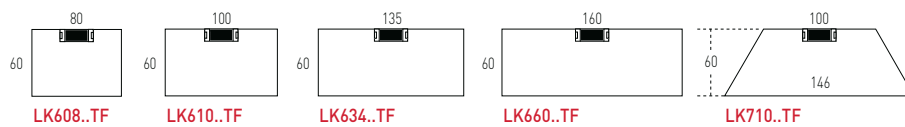

HEIGHT ADJUSTMENT

Min height. 74 cm and max 82 cm - 5 intervals

Work surfaces for the use of Link with a height adjustment system - Width 80 cm

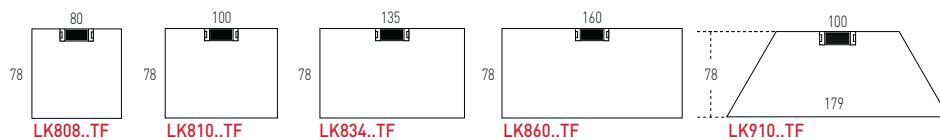

## 4. OPTIONAL ACCESSORIES FOR LINK

Made from 2 mm folded steel, finished in white epoxy paint, textured and with a unique design, optional accessories, which provide greater benefits to the workplace.



Double coat rack



Shelf



Magazine rack



Magnetic board



Support monitor



Cable tray



Cable riser

**LKC10** Double coat rack

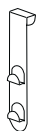

**LKC20** Shelf - bottom 22cm

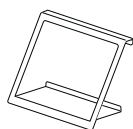

**LKC30** Magazine rack - 32x42 cm

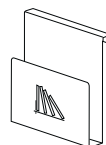

**LKC40** Magnetic board - 40x42 cm  
(magnets not included)

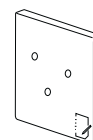

**LKC50** Support monitor - 37,5 cm  
(For panels of 130 cm height)

Sistema estandar de anclaje

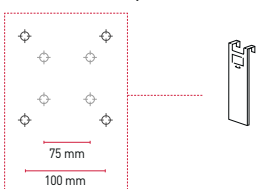

**LKC51** Support monitor - 75 cm  
(For panels of 170 cm height)

Sistema estandar de anclaje

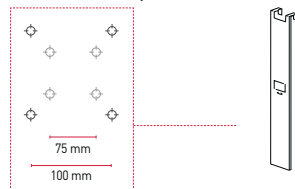

Cable tray

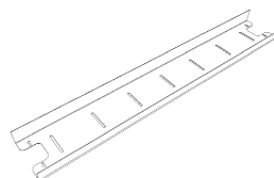

Polystyrene cable rise - Maximum length 132 cm



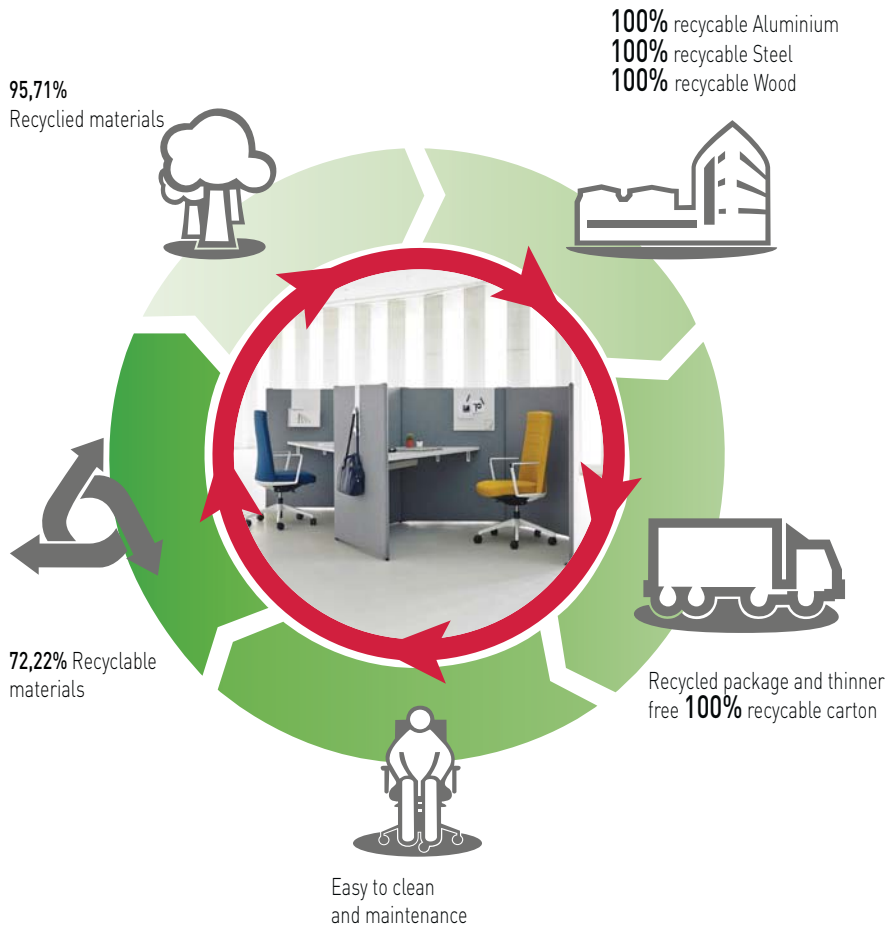

**MATERIALS**

LINK has been designed to be manufactured with recycled materials 95,71%, danger substances such as chrome, mercury or cadmium are not used in big quantity. Recyclables Aluminium and Steel 100%. Organic volatile Components. Packages manufactured with recycled carton. Ink thinner free.



**PRODUCTION**

Energy use is optimized during the production process. Minimum environmental impact. Last generation technological system in coating processes. Painting that have not been used is recovered to use it again. Zero COVs emissions and other contaminant gas. Close water circuit to clean the metals. Heat recovery. Automatic manufacture systems. Cut process is planned.



**TRANSPORT**

Optimum packaging to reduce space in transport and save energy.



**USE**

Long lasting use. Spare parts and replacements available. Easy to clean and maintenance.



**DISPOSAL**

72,22%. Recyclable. Easy and quick to split LINK components. Packages are reuse by our supplier to avoid waste generation. Carton used in packages is recyclable.

**CERTIFICATES AND REFERENCES**

The different programmes get points in different environmental categories to get the LEED certificate (sustainability, material and resources, water, energy and atmosphere, inner environment quality, innovation and design).



The mark of responsible forestry



PEFC Certificate



EN ISO 14006:2011  
ECODESIGN Certificate



UNE-EN ISO 9001:2008  
ISO 9001 Certificate



UNE-EN ISO 14001:2004  
ISO 14001 Certificate



E1 certificate by EN 13986



**ACTIU TECHNOLOGICAL PARK**  
project certified as LEED® GOLD  
by U. S. Green Building Council 2011  
Leadership in Energy & Environmental Design

■ REMARKABLE VALUES

**STURDINESS**

Stable and solid. A sturdy furniture. Without sacrificing precision finishes and where the details are treated with delicacy . To achieve this, we have the latest technology.

**ACCESSIBILITY**

Comfortable and open . We design furniture to meet the needs of the moment ; capable of helping to shape integrated workspaces that companies require today: more agile and comfortable , efficient and multifunctional. Modules that allow the separation of work spaces providing confidentiality and privacy. A solution of file storage and easy accessibility daily.

**ECOLOGY**

**ENERGY SAVING**

The new technological production system included, reduce the energy resources used to manufacture each component. Materials are very well used to avoid wastes.

**RECYCLED AND RECYCABLE MATERIALS**

ACTIU environmental policy opts to use recycled materials in those components where functionality and lasting is not a condition. Materials used in LINK such as aluminium, steel or wood are totally recyclable.

**SUSTAINABLE CERTIFICATE**

ACTIU has PEFC and FSC certificate to proof that the wood used in our products comes from sustainable exploitations and ECODESIGN. ISO 14006 certificate.

**ESTRUCTURE, JOINTS AND ACCESSORIES PAINTING PROCESS**

1 – Estructure covered with epoxy coating, bonding 2nd generation polymerized 200°C. Non-greasy treatments and nano-ceramics application to improve the coating so it becomes more resistance and long-lasting.

2 – Coating 80-90 micron thickness (it could be different as per the project requirements)

This covering guarantees the finish and maintenance of metal structures.

3 – Painting process:

Actiu painting plant has minimum environmental impact against the traditional industry processes.

Treatment is done by polarized coating and compacted with temperature. We get homogeneous and regular application with 98% of painting and the remaining 2% is used to produce other paints. Paints used are COVs free(Volatile Organic Components) which are very dangerous for the environment. All water used in the process is re-used, so we get zero dump. The process is free in heavy metal, phosphate, organic components and DQD (Biochemical demand of Oxygen). The program gives us an exact control of thickness, so it provides us with standard thickness (80-90 micron).

4 – ACTIU has **PEFC and FSC** certificate to proof that the wood used in our products comes from sustainable exploitations and **ECODESIGN** ISO 14006 certificate.



Witteveen Projectinrichting  
 Ouderkerk a/d Amstel  
 Tel: 020 - 496 5030  
 info@witteveen.nl  
 www.project-inrichting.nl  
 www.scheidingswand.net