



Witteveen Projectinrichting
Ouderkerk a/d Amstel
Tel: 020 - 496 5030
info@witteveen.nl
www.project-inrichting.nl
www.ergonomics.nl



MONITOR ARMS

Free up space, improve ergonomics, increase efficiency. A good monitor arm is an easy way to achieve major improvements. We have a wide selection of wall and desk arms for monitor screens in all environments.



NOTE!
New art.no. with new weight spans!

D-ZINE

A stable, diverse and very affordable gas spring arm with ideal ergonomic features for office use and wall mount for the home, hotel room or public spaces.

- Available in silver, black and white.
- Has a low gas pivot making it more ergonomical in use.
- It's attractive design is also strong and enduring.
- 3 mounting options included.



YOU D-ZINE!

Four graphic inlay design options included.



Weight span scale.



Smart clamp concept, more stable occupying minimal bracket space under the desk.

PRODUCT INFORMATION

Art.No	Size/Description <i>(all dimensions in mm)</i>	Colour	Price €
--------	---	--------	---------

D-Zine

The gas arm adjusts to the weight of the screen. Adjustable in all positions. Rotate 360°. Tilttable 185°. VESA 75 and 100. 4 graphic inlays included.

612525	Weight span 1,5-8,5 kg	silver	202,32
612525-1	Weight span 1,5-8,5 kg	white	202,32
612525-2	Weight span 1,5-8,5 kg	black	202,32
612526	Weight span 8-16 kg	silver	202,32
612526-1	Weight span 8-16 kg	white	202,32
612526-2	Weight span 8-16 kg	black	202,32

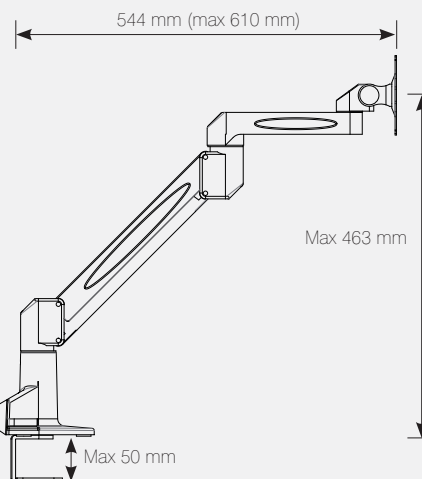
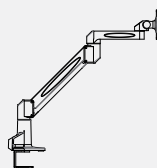

Mounting options included

Desk clamp, Grommet hole, Desk through M10 bolt. For mount on toolbar, see page 43.

You D-Zine

Four graphic inlay design options included.

Reach

Extension from 90 to 610 mm, vertical range 463 mm. Rotation 360 degrees. Tilt 180 degrees.

VESA Monitormount

VESA 75x100 is included. For monitors 24", 200x100 mm or 200x200 mm needs to be used. (art no. 610700 and 610705).

Product weight

Gross weight 4,2 kg, net weight 3,5 kg.

Accessories D-Zine

Gotessons Double bracket

Length 740 mm. Max width 670 mm/monitor. Weight 2 kg.

610504	silver	57,76
610504-1	white	57,76
610504-2	black	57,76



Metal plate for angled edge desks

When the clamps need stable grip with angled edge.

66500	W. 80 L. 110	silver	19,03
-------	--------------	--------	-------

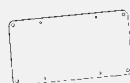

VESA-adapter plate 200x100

Adapter VESA attachment plate for 200x100 mm. Fits all arms. For larger monitors.

610700	silver	23,67
--------	--------	-------



VESA-adapter plate 200x200

Adapter VESA attachment plate for 200x200 mm. Fits all arms. For larger monitors.

610705	black	40,20
--------	-------	-------

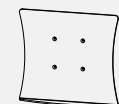

Laptop shelf for monitor arm

To be mounted to a separate arm. Suits VESA 100. Incl. velcro and elastics. See page 64.

671097	320x350 mm	silver	69,42
671097-1	320x350 mm	white	69,42
671097-2	320x350 mm	black	69,42





V3 MONITOR ARM

An competitive priced monitor arm with both clamp and desk mount option in one.

PRODUCT INFORMATION

Art.No	Size/Description <i>(all dimensions in mm)</i>	Colour	Price €
--------	---	--------	---------

V3 Monitor arm

Powder coated steel. Max height 400 mm. Max weight capacity 10 kg. Max armlength 420 mm. Rotates 360°. It comes with a desk clamp (60 mm) also suited for through desk mount (standard 80 mm). Incl. VESA attachment standard 75 and 100.

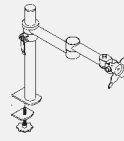

610510-50		silver	112,75
610510-60		white	112,75
610510-70		black	112,75

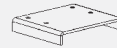

Metal plate for angled edge desks

When the clamps need stable grip with angled edge.

66500	W. 80 L. 110	silver	19,03
-------	--------------	--------	-------

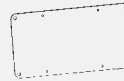

VESA-adapter plate 200x100

Adapter VESA attachment plate for 200x100 mm. Fits all arms. For larger monitors.

610700		silver	23,67
--------	--	--------	-------



VESA-adapter plate 200x200

Adapter VESA attachment plate for 200x200 mm. Fits all arms. For larger monitors.

610705		black	40,20
--------	--	-------	-------





D-ZINE DOUBLE COMPLETE

Double bracket for monitor, VESA 75 and 100.



V3 WITH GOTESSONS DOUBLE BRACKET

Double bracket for monitor, VESA 75 and 100.



V3 WITH SINGLE ARM AND LAPTOP SHELF

PRODUCT INFORMATION

Art.No	Size/Description <i>(all dimensions in mm)</i>	Colour	Price €
--------	---	--------	---------

D-Zine Double complete

*D-Zine arm with Gotessons Double bracket.
Gotessons Double bracket weight 2 kg.*

613525	Weight span 1,5-8,5 kg	silver	255,18
613525-1	Weight span 1,5-8,5 kg	white	255,18
613525-2	Weight span 1,5-8,5 kg	black	255,18
613526	Weight span 8-16 kg	silver	255,18
613526-1	Weight span 8-16 kg	white	255,18
613526-2	Weight span 8-16 kg	black	255,18

Gotessons Double bracket

Length 740 mm. Max width 670 mm/monitor. Weight 2 kg.

610504		silver	57,76
610504-1		white	57,76
610504-2		black	57,76

V3 Twin complete

1 pc 400 mm post, 1 pc Twin mount, 2 arms.

610511-50		silver	239,80
610511-60		white	239,80
610511-70		black	239,80

V3 Monitorarm

Powder coated steel. Max height 400 mm. Max weight capacity 10 kg. Max armlength 420 mm. Rotates 360°. It comes with a desk clamp (60 mm) also suited for through desk mount (standard 80 mm). Incl. VESA attachment standard 75 and 100.

610510-50 L. 420		silver	112,75
610510-60 L. 420		white	112,75
610510-70 L. 420		black	112,75

V3 Post 700 mm

Including desk clamp.

610562		silver	42,58
610562-1		white	42,58
610562-2		black	42,58

V3 Twin mount

For mounting two arms on one post. Order with one V3 Monitor arm and one V3 Single arm.

610516-50		silver	42,17
610516-60		white	42,17
610516-70		black	42,17

V3 Single arm without post

Max weight capacity 10 kg.

610517 L. 420		silver	84,88
610517-1 L. 420		white	84,88
610517-2 L. 420		black	84,88

Laptop shelf for monitor arm

*To be mounted to a separate arm. Suits VESA 100.
Incl. velcro and elastics.*

671097	320x350 mm	silver	69,42
671097-1	320x350 mm	white	69,42
671097-2	320x350 mm	black	69,42

Telephone/client holder for monitorarm

To be mounted to a separate arm. Suits VESA 100.

671095	230x240 mm	silver	33,98
671095-1	230x240 mm	white	33,98
671095-2	230x240 mm	black	33,98

Linjé DockIT shelf

Shelf made of silver-coloured wood or from smoke-coloured plexiglass. Incl. rubber mat and 2 adjustable stops. Suits VESA 100.

66510	Wood	410x410 mm	silver	33,41
66515	Plexi	410x410 mm	smoked	56,06

Double bracket = one bracket for two monitors.
Twin mount = one bracket for two separate monitors.



D-ZINE WALL 2



D-ZINE WALL 4



SLIM TV-MOUNT

Slim TV-mount: flexible bracket, turnable, rotatable with integrated cabling. 46 mm from the wall.



Tip!
See all arms, pictures
and videos at
www.gotessons.com



FLEXIBLE
TV WALL MOUNT



KEYBOARD HOLDER



WALL-IT

PRODUCT INFORMATION

Art.No	Size/Description <i>(all dimensions in mm)</i>	Colour	Price €
--------	---	--------	---------

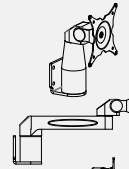

D-ZINE Wall 1
Max load 12 kg. L. 105 H.135
611527 silver -1 white -2 black

D-ZINE Wall 2
Max load 12 kg. L. 280 H. 135
611528 silver -1 white -2 black

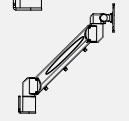

D-ZINE Wall 3
Gas arm. Incl. wall mount. Load span 1,5-8,5 kg. L. 470 H. 350
612325 silver -1 white -2 black

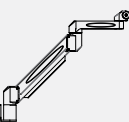

D-ZINE Wall 4
Gas arm. Incl. wall mount. Load span 1,5-8,5 kg. L. 650 H. 415
612425 silver -1 white -2 black

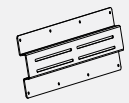

D-ZINE Wallbracket
A larger mount space. 250x150 mm.
610609 silver -1 white -2 black
A larger mount space. 640x230 mm.
610608 silver -1 white -2 black

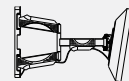

Slim TV-mount
Plasma/LCD/LED wall mount. Swivel 180° and tiltable -2°/+10°.
For most 32"-60" screens. Max weight 36 kg. Arm length 46-488 mm.
610566-2 black 81,09

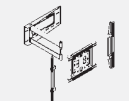

Flexible TV Wall mount
Plasma/LCD/LED wall mount. Adjustable 180° and can tilt
-5°/+15°. For most 32"-60" monitors. Max load 50 kg.
Arm length 120 - 800 mm.
610565-2 black 263,76



Wall-IT
Tilting wall mount. Max load 20 kg.
610300 black/silver 101,36



Keyboard holder
Shelf: 650x220 mm.VESA 75 och 100.
610604 silver -1 white -2 black 107,59

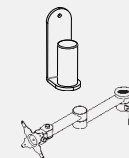

V3 wall mount
611515-50 silver -60 white -70 black 28,54

V3 Single arm without post
L 420 mm.
610517 silver -1 white -2 black 86,53



V3 Twin mount
For mounting two arms on one post. Order with one V3 Monitor
arm and one V3 Single arm.
610516-50 silver -60 white -70 black 42,99

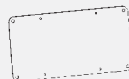

VESA-adapter plate 200x100 mm
Adapter VESA attachment plate. Fits all arms. For larger monitors.
610700 silver 23,67



VESA-adapter plate 200x200 mm
Adapter VESA attachment plate. Fits all arms. For larger monitors.
610705 black 40,20